

NIKKEN

CNC ROTARY TABLE SERIES

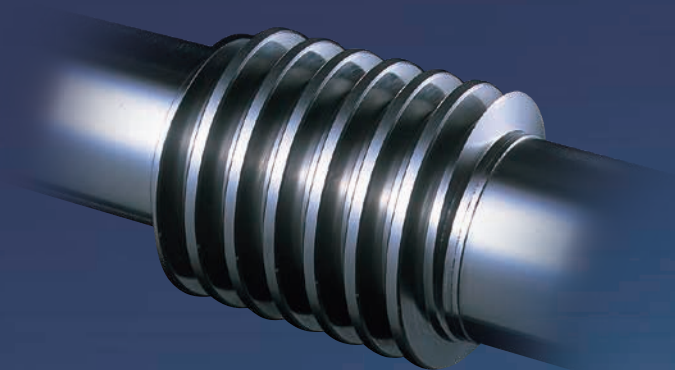

NIKKEN KOSAKUSHO WORKS, LTD.
CAT.NO.816J



NIKKEN KOSAKUSHO WORKS, LTD. OSAKA, JAPAN.

5-1, 1-chome, Minamishinden, Daito-shi, Osaka-fu, Japan. Telephone : 072-869-5820 Telefax : 072-869-6220

U.S.A CA, CT, IL, NC, TX, WA	LYNDEX-NIKKEN Inc 1468 Armour Boulevard, Mundelein, ILLINOIS 60060 Tel.+1-847-367-4800 Fax.+1-847-367-4815	P.R.CHINA	SHANGHAI ZHONG YAN TRADING CO., LTD. Room 321, Building 5, No. 456 Hongcao Road, Xuhui District, Shanghai, China Tel.+86-(0)-216210-2506 Fax.+86-(0)-216210-2083
MEXICO (From 2014.09)	HERRAMIENTAS LYNDEX-NIKKEN S.A.de C.V. Av. Hercules #401-13, Fracc. Poligono 3 Santa Rosa Jauregui, Queretaro 76220 Tel.+52-55-8421-8421	SINGAPORE	NIKKEN KOSAKUSHO ASIA PTE, LTD. 186, Woodlands Industrial Park E5 #04-01 M Singapore 757515 Tel.+65-6362-7980 Fax.+65-6362-7980
FRANCE	PROCOMO-NIKKEN S.A.S 6, avenue du 1er Mai-Z.A.E.Les Glaises 91127 Palaiseau Cedex Tel.+33-(0)-1-69.19.17.35 Fax.+33-(0)-1-69.30.64.68	THAILAND	SIAM NIKKEN Co., LTD. 127 Moo5 Gauwungjai-Bangturie Road Tambon Tanokkard Ampher Muangnakhonpathom Nakhonpathom 73000 Thailand Tel.+66(02)178-0503 Fax.+66(02)178-0504
UK	NIKKEN KOSAKUSHO EUROPE LTD. Advanced Manufacturing Park, Brindley Way, Rotherham S60 5FS Tel.+44-(0)-1709-366306 Fax.+44-(0)-1709-376683	INDONESIA	PT.NIKKEN KOSAKUSHO INDONESIA JALAN BIZPARK 3 JABABEKA INNOVATION CENTER A NO.16, KEL.MEKARMUJTI, KEC. CIKARANG UTARA, KAB. BEKASI PROP. JAWA BARAT TEL:+62-(0)21-5702071 MAIL:zefry.i@nikken-kosakusho.co.jp
GERMANY	NIKKEN DEUTSCHLAND GMBH CARL-ZEISS-STRASSE 11 NEU-ULM 89231 Tel.+49-731-963397-0 Fax.+49-731-963397-60		
ITALY	VEGA INTERNATIONAL TOOLS S.P.A Via Asti N° 9 10026-Santena(TORINO) Tel.+39-011-9497911 Fax.+39-011-9456380		
SCANDINAVIA SWEDEN	NIKKEN SCANDINAVIA AB Malmövägen 14 331 42 Värnamo Sweden Tel.+46-(0)-303-440-600 Fax.+46-(0)-303-58177		
SPAIN & PORTUGAL	UTILLAJES OLASA,S.L. C/ Aienas 3 - Nave 22 Pol. 27 (Mateo Gaina) 20014 Donostia - San Sebastián [Gipuzkoa] Tel.+34-(0)-943-107177 CUTTING TOOLS S.L Tel.+34-(0)-902-820090 Fax.+34-(0)-902-820099		
TURKEY	NIKKEN KESICI TAKIMLAR SAN. VE ULUSLARARASI TIC. A. S E5 Uzeri Kucukyali Yanyol Irmak Sok. Kucukyali Sanayi Sitesi A Blok No:5 Maltepe 34852 Istanbul Tel.+90-(0)-216-518-1010 Fax.+90-(0)-216-366-1414		
KOREA	KOREA NIKKEN LTD. 90B-11L, Namdong Industrial Complex, 170, Namdong-Daero, Namdong-Gu, Incheon, Korea 405-819 Tel.+82-(0)-32-763-4461 Fax.+82-(0)-32-763-4464		

<http://www.nikken-kosakusho.co.jp/en>
e-mail : export@nikken-kosakusho.co.jp

■ Please give your order to the following agent.

D.TK.1

● Specifications are subject to change without notice.

Made in Japan, Made by

NIKKEN is the manufacturers of CNC rotary tables that designs and manufactures in-house the key components of its rotary tables in order to realize the exceptional performance for customer requirements.

■ Spirit of Innovation In pursuit of exceptional performance

Our name "NIKKEN" means "Doing research & study every day", and this expresses the spirit of our company. This spirit is alive in every component of our CNC rotary tables. To achieve unmatched high precision, high rigidity, and durability, we utilize a variety of key components incorporating our own innovative ideas, rather than relying on off-the-shelf parts.

■ Long Life Concept In-house design and manufacturing for secure environment

Although our products are highly durable, it is naturally to replace parts occasionally. Since the key components are manufactured in-house, our customers avoid the risk of not being able to perform product repairs due to being discontinued off-the-shelf parts. You can continue to rely on our high-precision products under secure environment over the long term.

The Heart of NIKKEN CNC Rotary Table

Carbide Worm Screw System ●



■ Carbide Worm Screw

Carbide worm screw (Material : V grade carbide), hard and strong against high speed rotation, is used with ultra heavy duty, maintaining the high accuracy semi-permanently.

Comparing with the traditional worm system (steel worm screw and phosphor/aluminum bronze worm wheel), wearing of worm wheel is largely reduced and rotary table can be used for longer years, resulting in great cost-down. For better impact capability, the special alloy steel worm screw is used for the worm system of the small tooth module.



■ Harden Worm Wheel

The material used for the NIKKEN worm wheel is custom made steel, specially hardened and ion-nitrided on the teeth to eliminate the friction and gear wear.

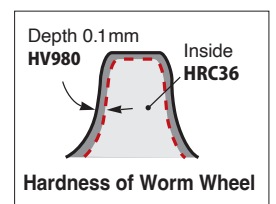

Unique "Bearing system"

Independent Double Thrust and Radial Bearing System ●

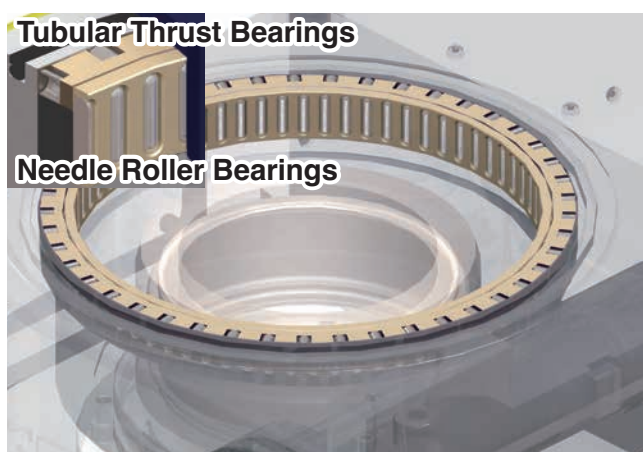

NIKKEN bearing system allow for more points of contact versus conventional cross roller bearings, resulting in smooth and accurate rotation.

■ Thrust: Tubular Roller Bearings

Tubular thrust bearings are pre-loaded for rigidity, and dampen vibration.

■ Radial: Needle Roller Bearings

"Hand picked and matched" needle roller bearings between rotary table body and table spindle are implemented for the high accuracy and rigidity.

*Worldwide Field-proven NIKKEN CNC Rotary Table.
Consequently and finally, NIKKEN Carbide Worm Screw System.*



RIGIDITY

ACCURACY

DURABILITY

Our thoroughgoing passion for high rigidity and high precision results in products of excellent durability that retain their precision even after long-term use. This boosts the operating ratio and cuts maintenance costs, contributing to a substantial reduction in costs overall.

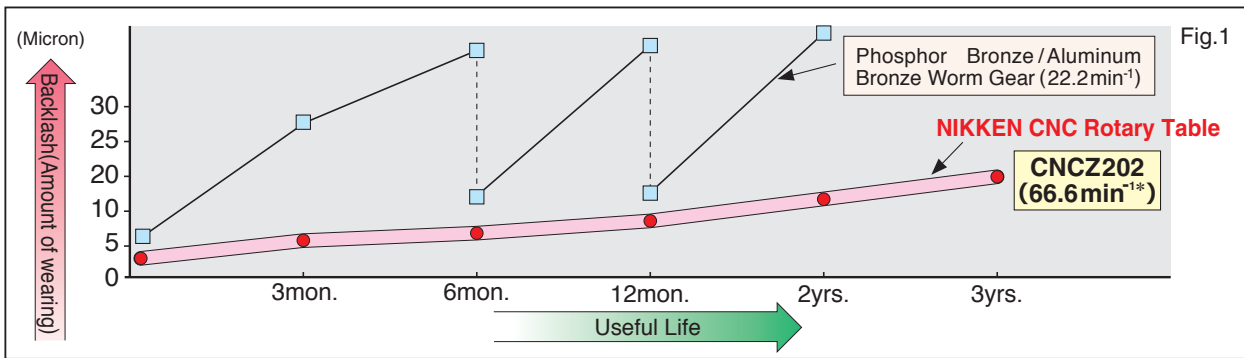

*It is the value of motor 3,000min⁻¹.

Work sample

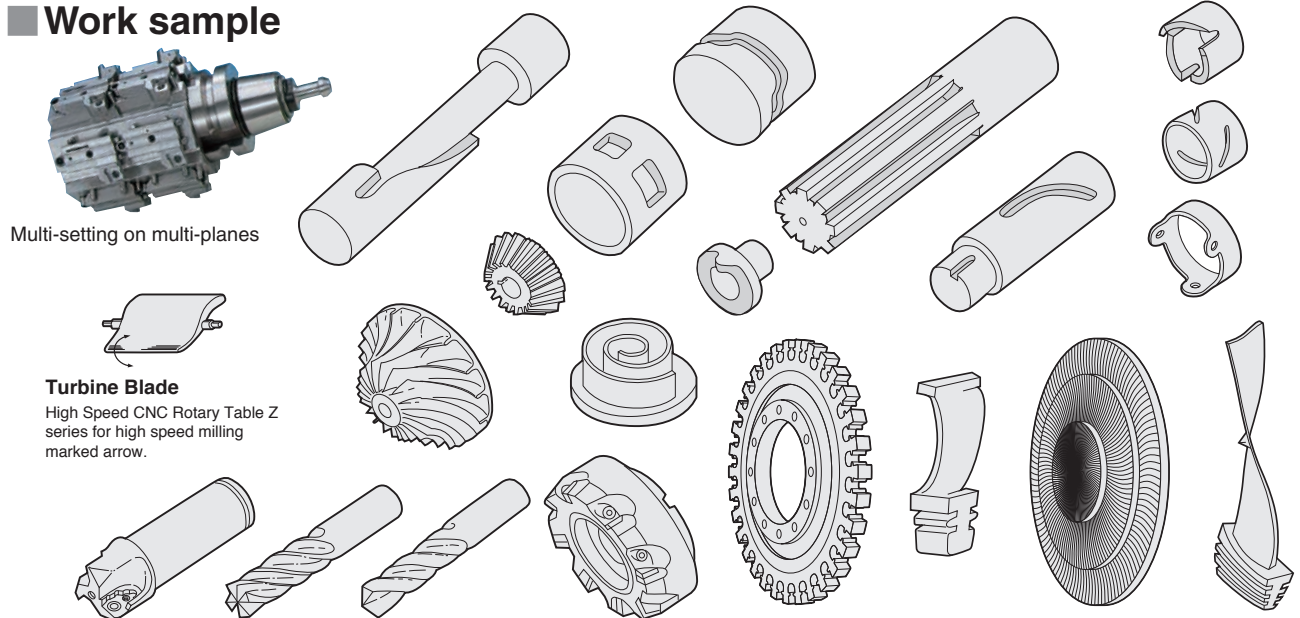

Multi-setting on multi-planes

Turbine Blade
High Speed CNC Rotary Table Z series for high speed milling marked arrow.

NIKKEN CNC rotary table extensive

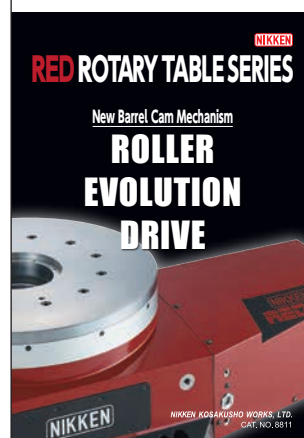
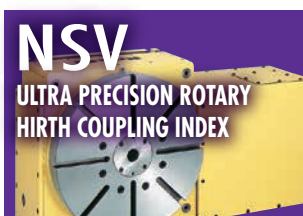
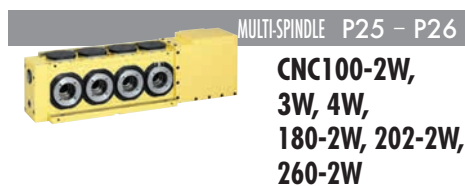
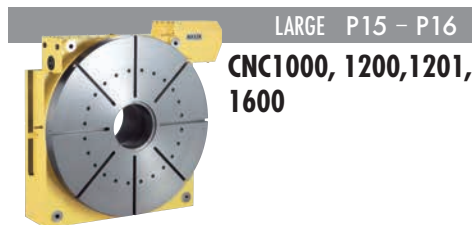
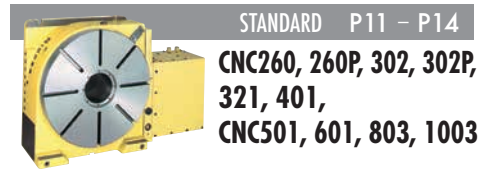
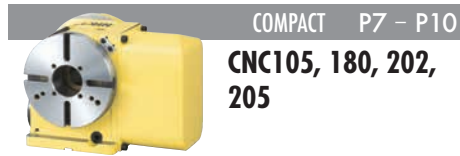

Please refer to RED ROTARY TABLE SERIES Catalogue.

lineup to match your own applications.

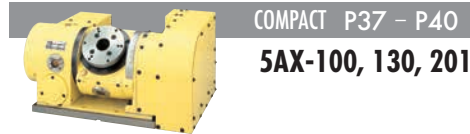
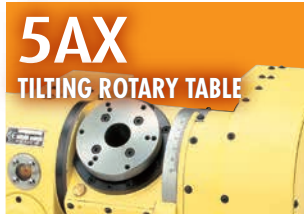

COMPACT P37 - P40
5AX-100, 130, 201

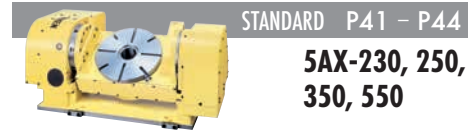

STANDARD P41 - P44
5AX-230, 250, 350, 550



LARGE P45 - P46
5AX-800, 1200



MULTI-SPINDLE P47 - P48
5AX-2MT-105, 4MT-105

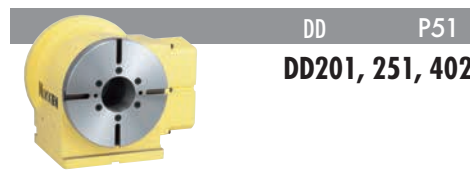

DD P51
DD201, 251, 402



5AX-DD P49 - P50 P52 - P53
5AX-DD100, 201A, 201B

Notes on the Use of DD TABLES P54

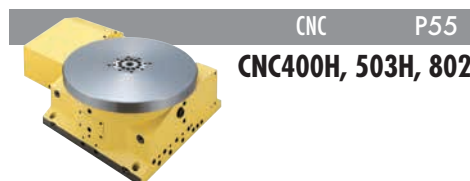
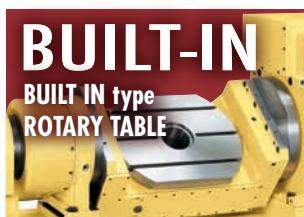

CNC P55
CNC400H, 503H, 802



5AX P56
5AX-T400, B450



SERVO MOTOR P57 - P58
Servo Motor List • Relation between Unbalancing load and Servo Motor • Flow Chart of the Additional Axis Control



AR21 CONTROLLER P59 - P68

TECHNICAL INFORMATION P69 - P70

ACC ACCESSORIES

- SUPPORT TABLE P71 - P72
- TAILSTOCK P73 - P74
- SCROLL CHUCK & POWER CHUCK P75 - P76
- CLAMPING DEVICE and T-NUT P77 - P78

O/P OPTIONAL EQUIPMENT

- High precision Indexing (Full Closed Loop) **NEW** Ultra-High precision Indexing (Full Closed Loop) P79 - P80
- ROTARY JOINT P81 - P84
- Multi Jig Fixture Holder System P85 - P90
- Waterproof Specification P91
- Special application support case P92 - P94

TEC TECHNICAL INFORMATION

- Accuracy Standard P95- P96
- Description of Specifications, Recommended Lubricating Oil and Quantity P97- P98
- Assessment P99
- Load Calculation, Indexing Time, Comparison, Durability P100
- Technical Information P101

SERV WORLDWIDE NETWORK

- Headquarter P102
- Overseas Sales & Service Network P103
- Worldwide Sales Branch P104-P108
- WormgearStatus / BacklashStatus P109
- Check Sheet for the Technical Specifications of CNC Rotary Table P110

How to Select Your Best CNC Rotary Table



1 How CNC Rotary Table is Controlled

Additional Axis

You can choose additional axis when the machine has 4th or 5th axis. CNC rotary table can be controlled by machine in this case.

1. 4th or 5th amplifier is required for the machine. It should be used exactly the same one used for X, Y and Z axis. Install same type of servomotor(s) used for X, Y and Z axis.
2. The capacity of the servomotor or amplifier is defined by the types of rotary table.
3. Decide who supplied the servomotor.
4. External dimensions and specifications depend on the type of servomotor.
5. Parameter configuration, hydraulic connection, wiring and installation of amplifiers should be provided by machine tool builders.

4th (or 5th) AXIS M/C

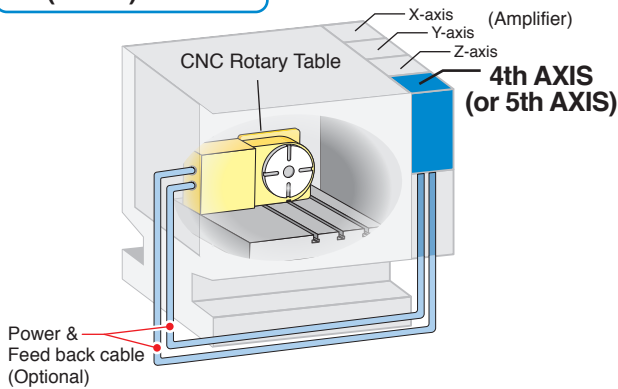

NIKKEN Controller (M-signal)

You can choose NIKKEN Controller when the machine doesn't have additional axis. Note: at least one M-signal code is required.

1. At least one M-Signal is required on the machine.
2. Input M-signal as "index start" command on the machine, high accuracy indexing, equally divided indexing (2-9999), or lead operation is allowed.
3. Control unit, servo-motor and all cables will be supplied by NIKKEN.

3th AXIS M/C

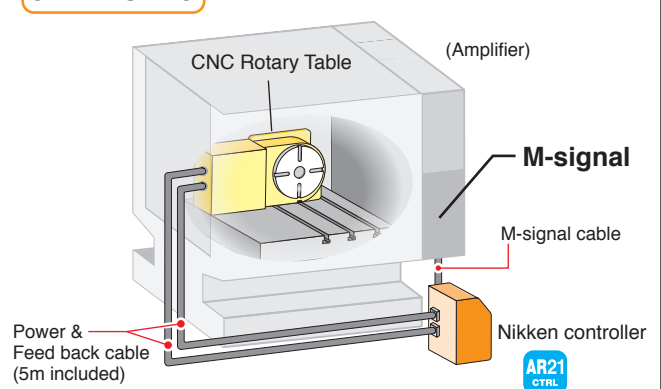

2 Select +1 AXIS or +2 AXIS



3 Select Face Plate Diameter

Component DIA.	Component Weight
Diameter of the components should not exceed the face plate diameter of the table. Ex.) Workpiece DIA. : $\phi 150$ Ex.) Workpiece DIA. : $\phi 180$	Component weight should not exceed the maximum load capacity. kg

4 Select the Servomotor Position



Select the servomotor position which is suitable for the application to take into consideration to avoid the interference with the machine.

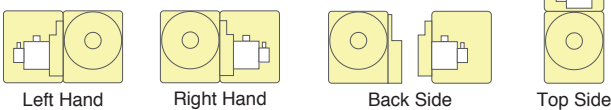

5 High Speed or Standard?



6 Select Options

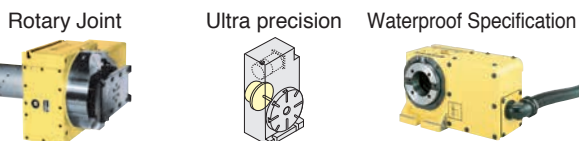

*Refer to icons on each page for the other functions.

7 Select Accessories



*Refer to icons on each page for the other functions.

8 Icon list (In this catalog, table Specifications, accessories, and option are displayed as icons.)



How to Read Product Code



CNC 401 L F A - M

- Code No. of vertical/horizontal type CNC rotary table
CNC : Standard
CNCZ : High Speed
- Diameter of the rotary table face plate (mm)
- Motor mounting location
Non: Right mount, L: Left mount,
B: Back mount, T: Top mount
- Maker code.*
- Type of motor
A: AC servo
- Non: Without motor
Supplied motor
M: With motor

* Maker code.	
Makers for Additional Axis Control	
* Maker code.	Makers for Additional Axis Control
F	FANUC
M	MELDAS
OSP	OSP
Y	YASNAC
Z	SIMENS
S	SANYO
TOS	TOSNUC
M-signal Control	
* Maker code.	M-signal Control
AR21	AR21 Controller
WAR21	*5AX : Both Axis
DAR21	*5AX : Each Axis

Servomotors for Brother **SPEEDIO** is exclusive. EX.)NCT□200□□SA-BR3
The last part of the product code must be "SA-BR3".

CNC180 (E) L F A - M

- CNC : Standard
CNCZ : High Speed
NCT : High Clamping Torque Compact
CNC rotary table
NCTZ : High Speed High Clamping
Torque Compact
CNC rotary table
- Diameter of the rotary table face plate (mm)
- Faceplate specification for NCT only
- Motor mounting location
Non: Right mount, L: Left mount,
B: Back mount, T: Top mount
- Motor maker
- Type of motor Non: DC servo, A: AC servo
- Non: Without motor, Supplied motor
M: With motor



CNC180

5AX- 350 F A - M

- Code No. of Rotray & Tilting Table
- Tilting axis motor mounting location
Non: Parallel mount
A: Back mount
B: Back of rotary axis
T: Top mount
- Diameter of the table face plate (mm)
- Rotary axis motor mounting location Non: Right mount, L: Left mount
- Motor maker
- Type of motor Non: DC servo, A: AC servo
- Non: Without motor
Supplied motor, M: With motor



5AX-350

Multi-Spindle CNC Rotary Table CNC100-2W-120 F A - M

- Code No. of vertical/horizontal type CNC rotary table
- Diameter of the rotary table face plate (mm)
- Number of spindles
- Pitch between the spindles 120, 250, 320
- Motor mounting location Non: Right mount,
L: Left mount, B: Back mount, T: Top mount
- Motor maker
- Type of motor Non: DC servo, A: AC servo
- Non: Without motor
Supplied motor, M: With motor



CNC100-2W

5AX Multi Spindle Rotary & Tilting Table 5AX-2MT-105-120- F A - M

- Code No. of Rotray & Tilt Table
- Number of rotary axis spindles
- Diameter of the table face plate (mm)
- Pitch distance between the spindles
- Tilting axis table size
- Rotary axis motor mount location
Non: Right mount, L: Left mount
- Motor maker
- Type of motor Non: DC servo, A: AC servo
- Non: Without motor
Supplied motor
M: With motor



5AX-2MT-105

Rotary Hirth Coupling Index Table NSV X 400 F A - M

- Code No. of Hirth Coupling Index Table
- X: Index & Rotary Table
Z: Index Table
- Diameter of the table face plate (mm)
- Motor mounting location Non: Right mount
L: Left mount, T: Top mount
- Motor maker
- Type of motor Non: DC servo, A: AC servo
- Non: Without motor
Supplied motor, M: With motor



NSVX400

Manual Tilting CNC Rotary Table NST 300 F A - M

- Code No. of Manual/Tilting CNC Rotary Table
- Diameter of the table face plate (mm)
- Motor maker
- Type of motor Non: DC servo, A: AC servo
- Non: Without motor
Supplied motor, M: With motor



NST300

COMPACT CNC ROTARY TABLE

NIKKEN









CNC105 and accessories

- Wide application can be offered from small drilling press to M/C
- Suitable for indexing/leads cutting of small size work pieces
- Various kinds of the work chucking attachments can be offered from 5C collet fixtures to the air/hyd. chuck



Specifications

(): High Speed CNC ROTARY Table Z series

Item / Code No.		CNC105 CNCZ105	CNC180 CNCZ180	CNC202 CNCZ202
Diameter of Table	φmm	105	180	200
Diameter of Spindle Hole	φmm	φ60H7 φ30	φ60H7 φ40	φ60H7 φ40
Center Height	mm	105	135	135
Width of T Slot	mm	φ10H7 Pin hole	12 ^{+0.018} ₀	12 ^{+0.018} ₀
Clamping System		Pneumatic*3	Pneumatic*3	Pneumatic*3
Clamping Torque	N·m	205	303	303
Table Inertia at Motor Shaft ($\frac{GD^2}{4}$)	kg·m ² ×10 ⁻³	0.06	0.08	0.09
Servo Motor	r/min	α iF1·3000	α iF2·3000	α iF4·3000
MIN. Increment		0.001°	0.001°	0.001°
Rotation Speed*4	r/min	33.3(66.6)	33.3(66.6)	33.3(66.6)
Total Reduction Ratio		1/90(1/45)	1/90(1/45)	1/90(1/45)
Indexing Accuracy	sec	±30	±20	±20
Net Weight	kg	32	45	55
MAX. Work Load on the Table	Vertical  kg	30	100	100
	Horizontal  kg	60	200	200
MAX. Thrust Load applicable on the Table	 N	8800	18000	18000
	*1  F × L N · m	275	542	542
	 F × L N · m	220	690	690
Guide Line of MAX. Unbalancing Load	*2  N · m	-	30	50
MAX. Work Inertia	Vertical  ($\frac{GD^2}{4}$) kg·m ²	0.04(0.02)	0.4(0.2)	1.0(0.5)
Driving Torque	 N · m	36(27)	72(54)	144(115)

*1 This is the strength of the worm wheel without brake. It is applied against dynamic cutting thrust.

*2 The guide line of MAX unbalancing load means the unbalancing load, when the rotary table is used with support table in vertical application. The guide line figure will be different according to the servo motor, please refer to **P.57** for more detail.

*3 Air Intensifying Booster system is available if the supplied air pressure is under 0.5MPa or the brake torque is required to increase. **P.91**

*4 The table rotation speed when the motor rotates at 3000r/min. Depending on the application(unbalance of the jig,work) and the motor specification, the motor may not be able to rotate at 3000r/min. ★ α iF4/5000 motor can be mounted on **CNC180**.

★ Driving torque means the torque at MAX. rotation speed after acceleration. Driving torque is almost constant and independent from the load except unbalancing load is applied.

CNC105, 180, 202



External dimensions depend on the type of the servo motor. Indicated dimensions are in case of FANUC. Please contact us for CAD files (2D:DXF, 3D:PARASOLID).

CNC105, CNCZ105

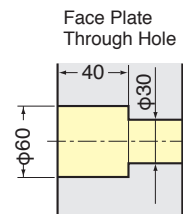
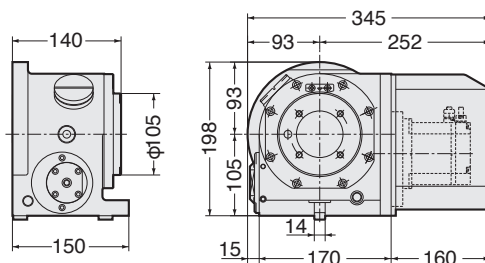

Clamp Device

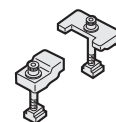

Air purge function is provided inside the motor cover as standard.

CNC180, CNCZ180

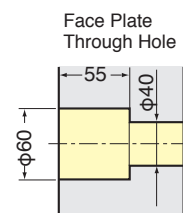
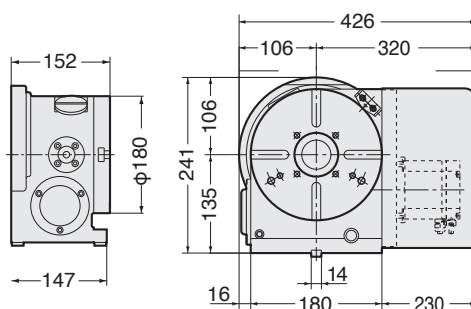

Clamp Device

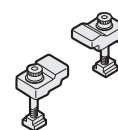

Air purge function is provided inside the motor cover as standard.

CNC202, CNCZ202

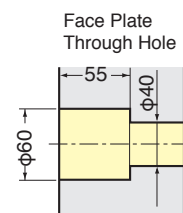
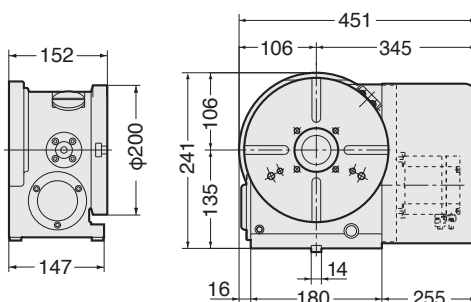

Clamp Device

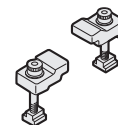

Air purge function is provided inside the motor cover as standard.

COMPACT CNC ROTARY TABLE

NIKKEN

Ultra Slim Model for Trunnion Application

CNC205



380Nm

Air-hydraulic Unit Provided as Standard Equipment

Astoundingly powerful clamping capability in spite of the slim body

For machines with no hydraulic power source, the air-hydro unit provides powerful hydraulic supply functionality using only an air supply. In spite of its slim body, it delivers an astounding 380 Nm of clamping power, enabling a variety of applications, such as use of a cradle jig.

Ultra-Slim 98mm

Ultrathin Specification to Maximize Machining Space

Demonstrates the true worth of a compact machining center with limited machining space.

The body thickness of 98mm is 54mm slimmer than previous models. Allows enlargement of the cradle jig work mounting area on machines with limited machining space, such as the BT30 compact machining center.

High Speed

Z Type is also Available

Reducing cycle time enhances productivity

The lineup also includes the highly rotatable Z type that further reduces machining cycle time. By setting the speed reduction ratio to 1/2 that of the standard type, 200% speedup is achieved.

Built-in Rotary Joint

Supports Mounting of Built-in Rotary Joints

Automated component mounting/unmounting with minimal increase in size.

The rotary table body is already provided with IN ports, so the rotary joint specification can be changed with minimal increase in the body dimensions.

Ultra-slim Support

Ultrathin Support Table is also Available.

Contributes to a further expansion of machining area when used with the CNC205.

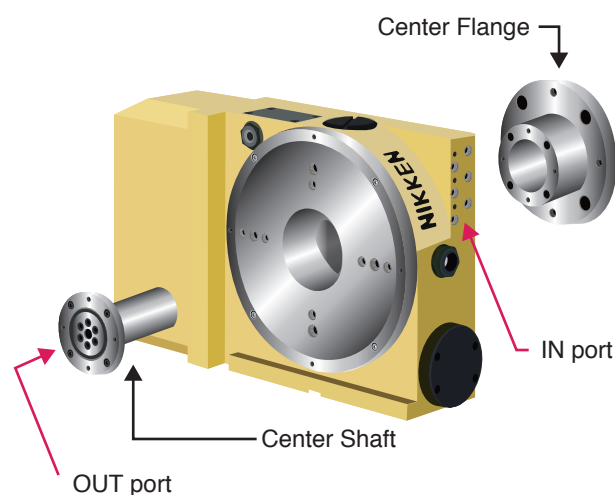
Ultrathin Support Table with Clamping System
Ex.) Trunnion Application with CNC205L and a Support Table

TAS-100N



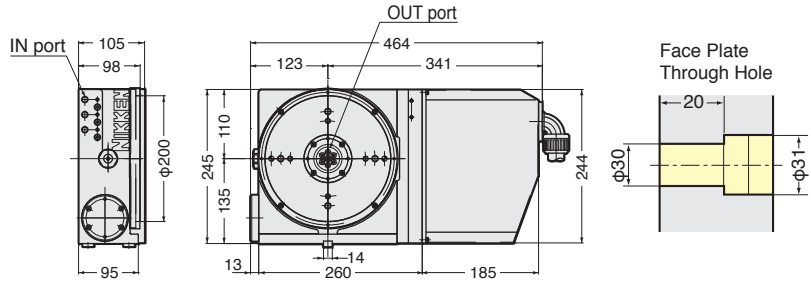





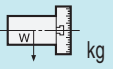
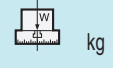

Rotary joint shown in photo is optional.

*Rotary joint is included in the layout with AR21 controller.

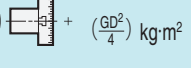
Specifications

Item / Code No.		Standard	High Speed
Right Hand Mounted Moter		CNC205	CNCZ205
Left Hand Mounted Moter		CNC205L	CNCZ205L
Diameter of Table	φmm	200	200
Diameter of Spindle Hole	φmm	φ30H7	φ30H7
Center Height	mm	135	135
Width of T Slot	mm	—	—
Clamping System		Air Hydraulic Booster Built-in type	Air Hydraulic Booster Built-in type
Clamping Torque	N·m	380	380
Table Inertia at Motor Shaft ($\frac{GD^2}{4}$)	kg·m ² ×10 ⁻³	0.15	0.15
Servo Motor	r/min	α iF2·3000	α iF2·3000
MIN. Increment		0.001°	0.001°
Rotation Speed*3	r/min	33.3	66.6
Total Reduction Ratio		1/90	1/45
Indexing Accuracy	sec	±20	±20
Net Weight	kg	45	45
MAX. Work Load on the Table	Vertical 	100 (with support)	100 (with support)
	Horizontal 	—	—
MAX. Thrust Load applicable on the Table	*1 	670	670
		690	690
Guide Line of MAX. Unbalancing Load	*2 	30	30
MAX. Work Inertia	Vertical 	0.40	0.20
Driving Torque		72	54

*1 This is the strength of the worm wheel without brake. It is applied against dynamic cutting thrust.

*2 The guide line of MAX unbalancing load means the unbalancing load, when the rotary table is used with support table in vertical application. The guide line figure will be different according to the servo motor, please refer to P.57 for more detail.

*3 The table rotation speed when the motor rotates at 3000r/min. Depending on the application(unbalance of the jig,work) and the motor specification, the motor may not be able to rotate at 3000r/min.

★Driving torque means the torque at MAX. rotation speed after acceleration. Driving torque is almost constant and independent from the load except unbalancing load is applied.

STANDARD CNC ROTARY TABLE

NIKKEN









CNC260

- The rotary table can be used vertically or horizontally depending on the application
- Best match for a medium-size machining center
- Standard model with motors mounted on the body side

Option				Accessories					
ADD. AXIS	ACCURACY SPEC.	ROTARY JOINT	ULTRA PRECISION	SUPPORT TABLE	TAIL STOCK	SCROLL CHUCK	POWER CHUCK	CLAMP DEVICE	T-NUT
P.57	P.95	P.81	P.79	P.71	P.73	P.75	P.76	P.77	P.78

Specifications

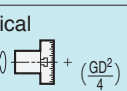
(): High Speed CNC ROTARY Table Z series

Item / Code No.		CNC260 CNCZ260	CNC260P CNCZ260P	CNC302*3 CNCZ302	CNC302P CNCZ302P	CNC321*3 CNCZ321	CNC401 CNCZ401
Diameter of Table	φmm	260	260	300	300	320	400
Diameter of Spindle Hole	φmm	φ80H7	φ80H7	φ80H7	φ80H7	φ105H7	φ105H7
Center Height	mm	170	170	170	170	230	230
Width of T Slot	mm	12 ^{+0.018} ₀	12 ^{+0.018} ₀	12 ^{+0.018} ₀	12 ^{+0.018} ₀	12 ^{+0.018} ₀	14 ^{+0.018} ₀
Clamping System*5		Hydraulic	Pneumatic	Hydraulic	Pneumatic	Hydraulic	Hydraulic
Clamping Torque	N·m	1568	1430	1568	1430	1760	1760
Table Inertia at Motor Shaft ($\frac{GD^2}{4}$)	kg·m ² ×10 ⁻³	0.33	0.33	0.33	0.33	2.8	2.8
Servo Motor	r/min	αiF4·3000	αiF4·3000	αiF4·3000	αiF4·3000	αiF12·2000	αiF12·2000
MIN. Increment		0.001°	0.001°	0.001°	0.001°	0.001°	0.001°
Rotation Speed*4	r/min	25.0(50.0)	25.0(50.0)	25.0(50.0)	25.0(50.0)	22.2(44.4)	22.2(44.4)
Total Reduction Ratio		1/120(1/60)	1/120(1/60)	1/120(1/60)	1/120(1/60)	1/90(1/45)	1/90(1/45)
Indexing Accuracy	sec	20	20	20	20	15	15
Net Weight	kg	115	115	120	120	200	230
MAX. Work Load on the Table	Vertical  kg	175	175	175	175	250	250
	Horizontal  kg	350	350	350	350	500	500
MAX. Thrust Load applicable on the Table	 N	42480	42480	42480	42480	53100	53100
	*1  FXL N·m	1442	1442	1442	1442	2648	2648
	 FXL N·m	2320	2320	2320	2320	3840	3840
Guide Line of MAX. Unbalancing Load	*2  N·m	50	50	50	50	100	100
MAX. Work Inertia	Vertical  ($\frac{GD^2}{4}$) kg·m ²	3.2(1.6)	3.2(1.6)	3.2(1.6)	3.2(1.6)	6.4(3.2)	6.4(3.2)
Driving Torque	 N·m	192(153)	192(153)	192(153)	192(153)	432(345)	432(345)

*1 This is the strength of the worm wheel without brake. It is applied against dynamic cutting thrust.

*2 The guide line of MAX unbalancing load means the unbalancing load, when the rotary table is used with support table in vertical application. The guide line figure will be different according to the servo motor, please refer to  P.57 for more detail.

*3 CNC302,321 is semi-standard model. *4 The table rotation speed when the motor rotates at 3000r/min. Depending on the application(unbalance of the jig,work) and the motor specification, the motor may not be able to rotate at 3000r/min.

*5 The air brake version of the existing CNC260 (302) has been discontinued, so please select the new CNC260P (302P).

★The air-hydraulic booster is available, when the rotary table with hydraulic clamping system is used on the M/C without hydraulic source, please refer to  P.91.

★αiF8/4000 motor can be mounted on CNC260, 302, CNC260P, 302P.

★Driving torque means the torque at MAX. rotation speed after acceleration. Driving torque is almost constant and independent from the load except unbalancing load is applied.

CNC260, 260P, 302, 302P, 321, 401



External dimensions depend on the type of the servo motor. Indicated dimensions are in case of FANUC. Please contact us for CAD files (2D:DXF, 3D:PARASOLID).

CNC260, CNCZ260, CNC302, CNCZ302

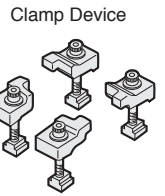
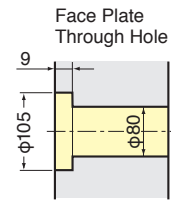
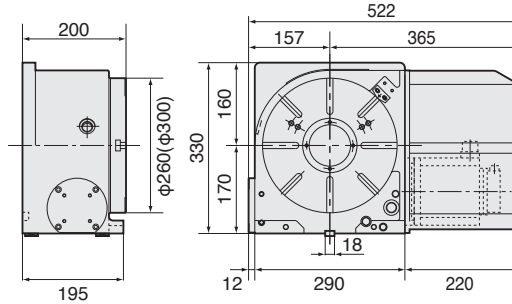

() : Figures is for CNC302, CNCZ302.

CNC260P, CNCZ260P, CNC302P, CNCZ302P

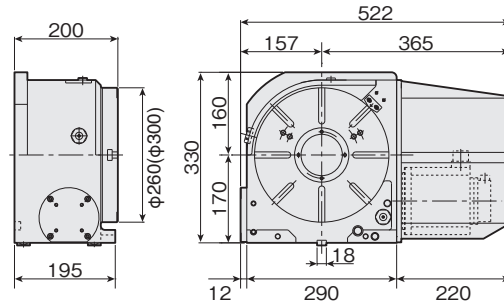

Powerful Clamping Torque: 1430N·m

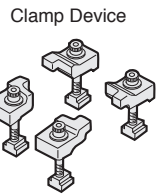
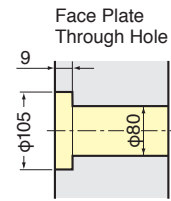

() : Figures is for CNC302P.

Air purge function is provided inside the motor cover as standard.

CNC321, CNCZ321

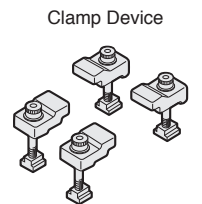
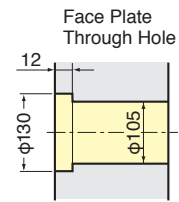
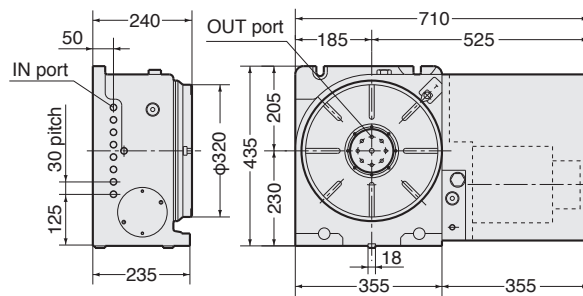
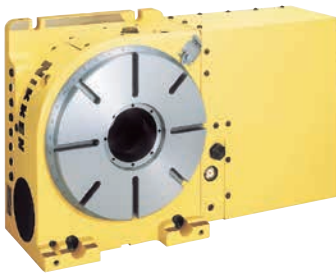

Rotary joint shown in layout is optional.

CNC401, CNCZ401

Rotary joint shown in photo & layout is optional.

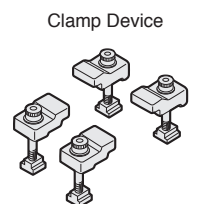
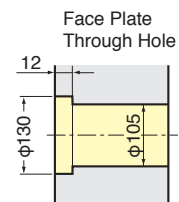
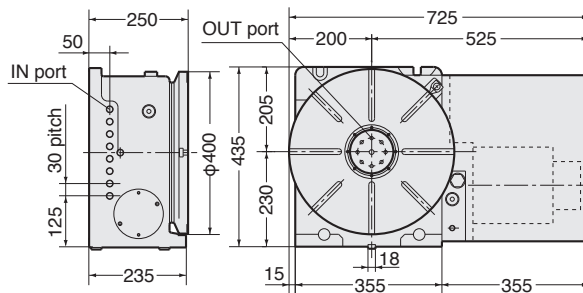
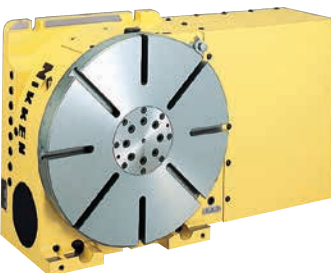

STANDARD CNC ROTARY TABLE

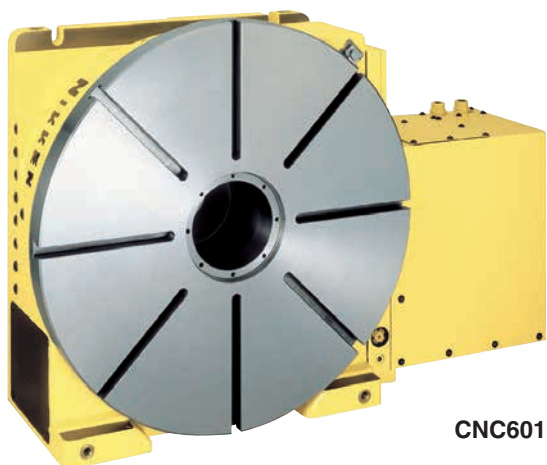







NIKKEN

CNC601

- Dividing and lead cutting for large size work piece is suitable
- Large through hole and powerful clamping system
- Ideal for deep cutting of highly rigid material

Option				Accessories					
ADD. AXIS	ACCURACY SPEC.	ROTARY JOINT	ULTRA PRECISION	SUPPORT TABLE	TAIL STOCK	SCROLL CHUCK	POWER CHUCK	CLAMP DEVICE	T-NUT
P.57	P.95	P.81	P.79	P.71	P.73	P.75	P.76	P.77	P.78

Specifications

Item / Code No.		CNC501	CNC601	CNC803	CNC1003
Diameter of Table	φmm	500	600	800	1000
Diameter of Spindle Hole	φmm	Φ130H7	Φ130H7	Φ230H7	Φ230H7
Center Height	mm	310	310	550	550
Width of T Slot	mm	14 $^{+0.018}_0$	14 $^{+0.018}_0$	22H7*3	22H7*3
Clamping System		Hydraulic	Hydraulic	Hydraulic	Hydraulic
Clamping Torque	N·m	4655	4655	7000	7000
Table Inertia at Motor Shaft	$(\frac{GD^2}{4}) \text{ kg}\cdot\text{m}^2 \times 10^{-3}$	6.8	4.9	6.2	6.3
Servo Motor	r/min	αiF12·2000	αiF12·2000	αiF30·2000	αiF30·2000
MIN. Increment		0.001°	0.001°	0.001°	0.001°
Rotation Speed	r/min	16.6	11.1	5.5	5.5
Total Reduction Ratio		1/120	1/180	1/360	1/360
Indexing Accuracy	sec	15	15	15	15
Net Weight	kg	470	500	2070	2210
MAX. Work Load on the Table	Vertical  kg	400	400	2000	2000
	Horizontal  kg	800	800	4000	4000
MAX. Thrust Load applicable on the Table	 N	150000	150000	281250	281250
	*1  F×L N·m	5709	5709	20067	20067
	 F×L N·m	16650	16650	42190	42190
Guide Line of MAX. Unbalancing Load	*2  N·m	200	200	300	300
MAX. Work Inertia	Vertical  $(\frac{GD^2}{4}) \text{ kg}\cdot\text{m}^2$	19.4	37	234	234
Driving Torque	 N·m	576	864	3168	3168

*1 This is the strength of the worm wheel without brake. It is applied against dynamic cutting thrust.

*2 The guide line of MAX unbalancing load means the unbalancing load, when the rotary table is used with support table in vertical application. The guide line figure will be different according to the servo motor, please refer to  P.57 for more detail.

*3 Standard large rotary tables are without T slot. T slot is available as an option, please specify the width of the T slot.

★ Total reduction ratio of 1/180 is also available for CNC501. ★ αiF22/4000 motor can be mounted on CNC501, 601.

CNC501, 601, 803, 1003



External dimensions depend on the type of the servo motor. Indicated dimensions are in case of FANUC. Please contact us for CAD files (2D:DXF, 3D:PARASOLID).

CNC501

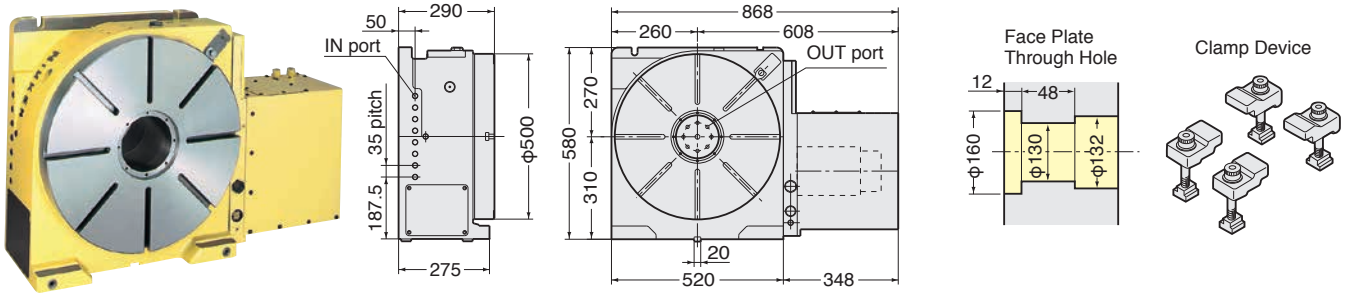

Rotary joint shown in layout is optional.

CNC601

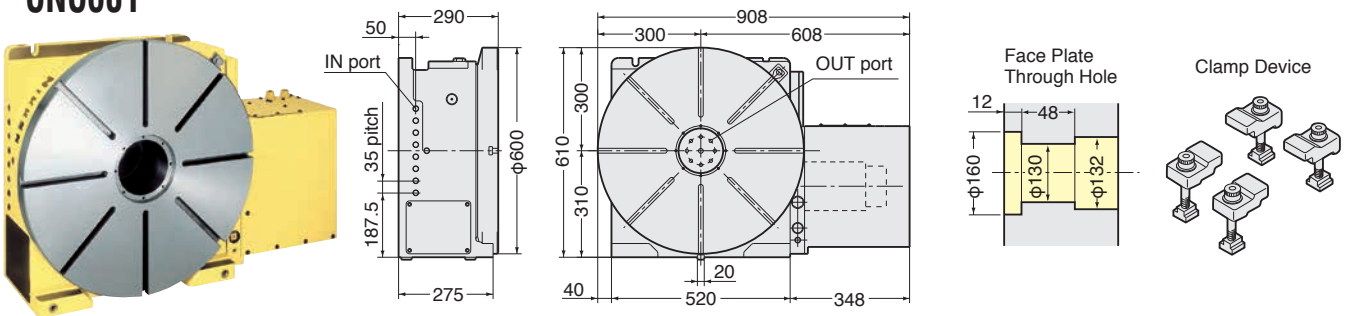

Rotary joint shown in layout is optional.

CNC803

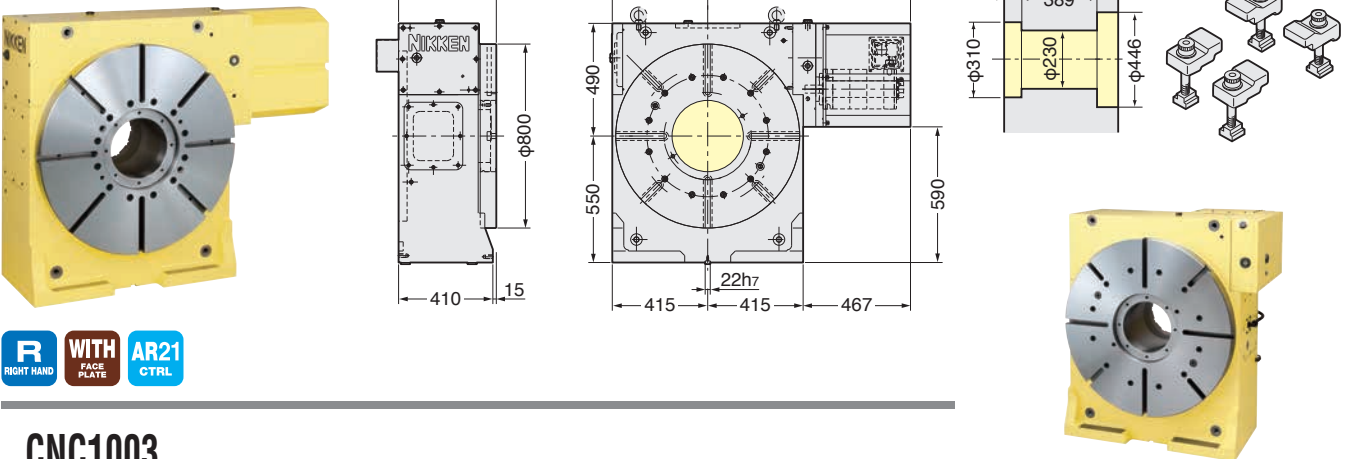

CNC1003

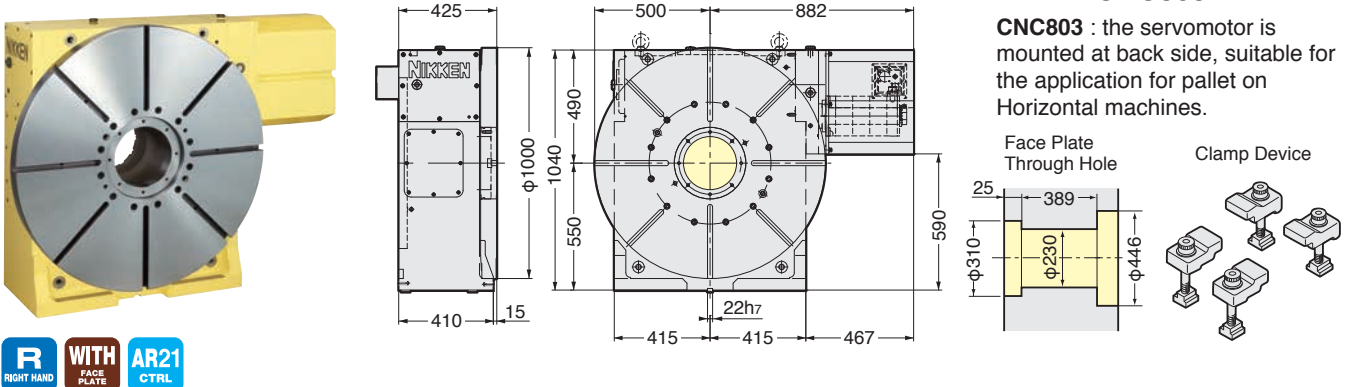

CNC803B

CNC803 : the servomotor is mounted at back side, suitable for the application for pallet on Horizontal machines.

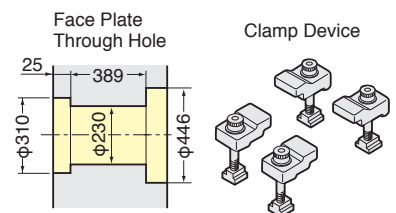

LARGE CNC ROTARY TABLE

NIKKEN







CNC1600

- Ideal for indexing and lead cutting of large work pieces
- Tooth thickness module 10 and ultrahigh rigidity among best in class.(CNC1600)
- Ideal for aircraft- and energy-related parts



Specifications

The specification will be varied according to your application. Please contact us.

Item / Code No.		CNC1000*1	CNC1200*1	CNC1201*1	CNC1600*1
Diameter of Table	φmm	1000	1200	1200	1600
Diameter of Spindle Hole *2	φmm	φ300H7	φ300H7	φ300H7	φ400H7
Center Height	mm	Horizontal	Horizontal	650	850
Width of T Slot *3	mm	22H7*3	22H7*3	22H7*3	28H7*3
Clamping System		Hydraulic	Hydraulic	Hydraulic	Hydraulic
Clamping Torque	N·m	18000	18000	18000	35000
Servo Motor	r/min	αiF22·2000		αiF30·2000	
MIN. Increment		0.001°	0.001°	0.001	0.001
Rotation Speed	r/min	5.5	5.5	2.7	2.7
Total Reduction Ratio *4		1/360	1/360	1/720	1/720
Indexing Accuracy	sec	15	15	15	15
Indexing Accuracy of Ultra Precision	sec	±3	±3	±3	±3
Net Weight	kg	1700	1850	3500*5	5250*5
MAX. Work Load on the Table	Vertical  kg	—	—	6500	10000
	Horizontal  kg	7000	7000	13000	30000
MAX. Thrust Load applicable on the Table	 N	281250	375000	1333330	2000000
	*6  FXL N·m	24080	24080	79025	111952
	 FXL N·m	42190	67500	240000	510000
MAX. Work Inertia	Vertical  kg·m ²	1300	1300	2300	6400
Driving Torque	 N·m	3168	3168	8640	8640

*1 CNC1000, 1200, 1600 is semi-standard model.

*2 The diameter of the spindle hole is restricted for the ultra precision type with Heidenhain rotary encoder.

*3 Standard large rotary tables are without T slot. T slot is available as an option, please specify the width of the T slot.

*4 Total reduction ratio and motor can be changed according to your application, please contact us.

*5 Net weight of the rotary table is for horizontal application. The weight of the back support for vertical application is not included.

*6 This is the strength of the worm wheel without brake. It is applied against dynamic cutting thrust.

CNC1000, 1200, 1201, 1600



External dimensions depend on the type of the servo motor. Indicated dimensions are in case of FANUC. Please contact us for CAD files (2D:DXF, 3D:PARASOLID).

CNC1000,1200

★ Exclusively for Horizontal models.

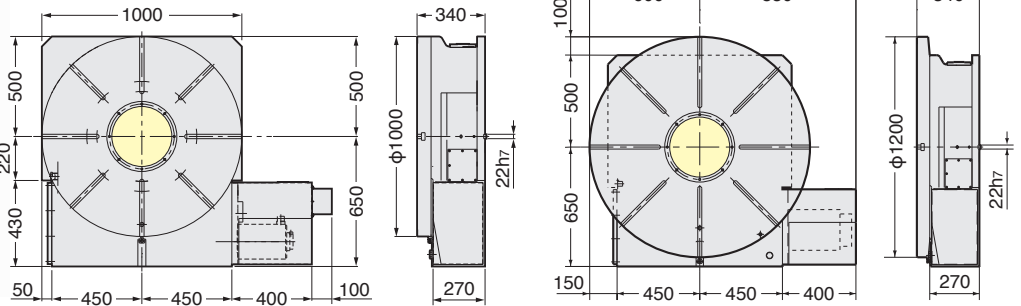
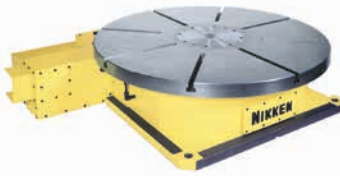

CNC1201 PAT.

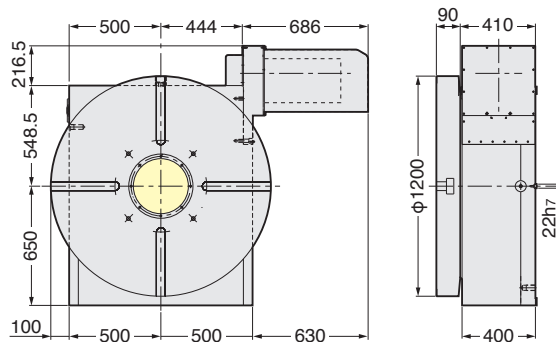
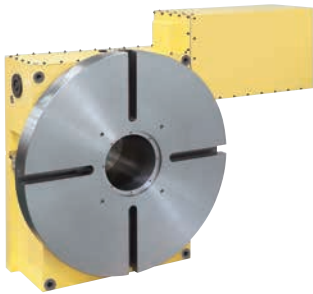

★ Please contact us about the back support for vertical use.

CNC1600 PAT.

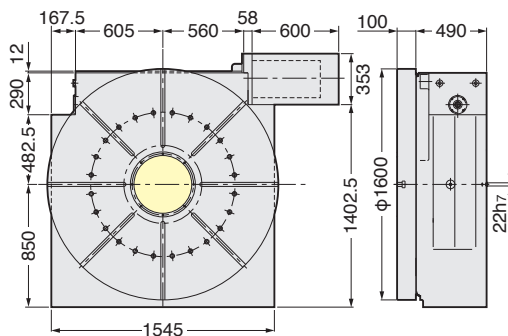
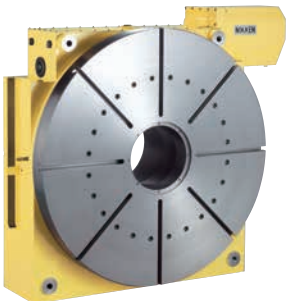

★ Please contact us about the back support for vertical use.

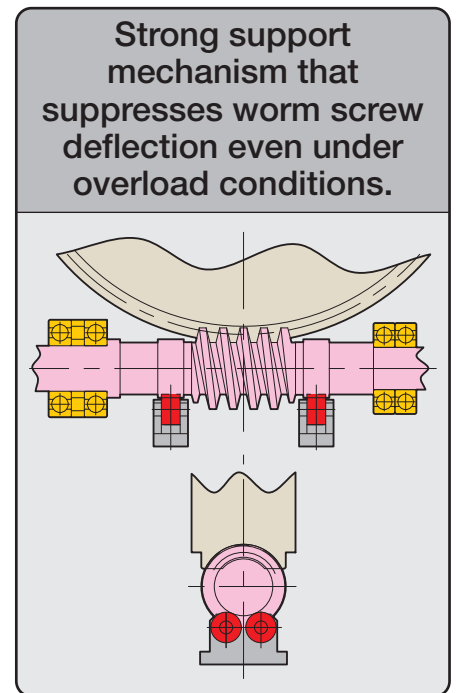

Application of the Large Rotary Table

Machining of the gears with large module

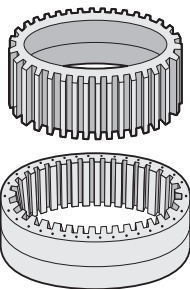

Hobbing of the gears with large module

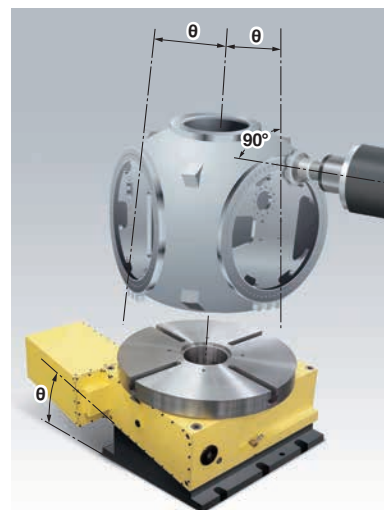
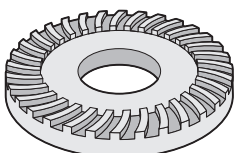

Configuration of the large rotary table on the horizontal M/C to machine a propeller hub of the windmill.

TOP SIDE MOTOR MOUNTED CNC ROTARY TABLE

NIKKEN

CNC302T

■ Ideal for automation of small parts by mounting of jig holder

Also ideal for B-axis of general-purpose horizontal machining center. Figure at right shows example of pallet mounting. Please specify A, B, C, D and E.

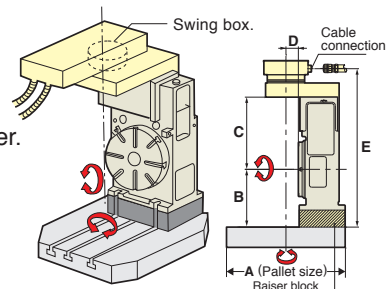

Option				Accessories					
ADD. AXIS	ACCURACY SPEC.	ROTARY JOINT	ULTRA PRECISION	SUPPORT TABLE	TAIL STOCK	SCROLL CHUCK	POWER CHUCK	CLAMP DEVICE	T-NUT
P.57	P.95	P.81	P.79	P.71	P.73	P.75	P.76	P.77	P.78

Specifications

Item / Code No.		CNC202T	CNC260T	CNC302T*4
Diameter of Table	φmm	200	260	300
Diameter of Spindle Hole	φmm	φ60H7 φ40	φ80H7	φ80H7
Center Height	mm	150	170	170
Width of T Slot	mm	12 ^{+0.018} ₀	12 ^{+0.018} ₀	12 ^{+0.018} ₀
Clamping System		Pneumatic*3	Pneumatic*3 / Hydraulic	Pneumatic*3 / Hydraulic
Clamping Torque	N·m	303	588 / 1568	588 / 1568
Table Inertia at Motor Shaft $(\frac{GD^2}{4})$	kg·m ² ×10 ⁻³	1.0	1.5	1.5
Servo Motor	r/min	αiF4·3000	αiF4·3000	αiF4·3000
MIN. Increment		0.001°	0.001°	0.001°
Rotation Speed*5	r/min	25.0	25.0	25.0
Total Reduction Ratio		1/120	1/120	1/120
Indexing Accuracy	sec	±20	20	20
Net Weight	kg	70	160	165
MAX. Work Load on the Table	Vertical	100 kg	175	175
	Horizontal	—	—	—
MAX. Thrust Load applicable on the Table		18000 N	42480	42480
	*1	542 FXL N·m	1442	1442
		690 FXL N·m	2320	2320
Guide Line of MAX. Unbalancing Load	*2	50 N·m	60	60
MAX. Work Inertia	Vertical	1.0 $(\frac{GD^2}{4})$ kg·m ²	3.2	3.2
Driving Torque		192 N·m	192	192

*1 This is the strength of the worm wheel without brake. It is applied against dynamic cutting thrust.

*2 The guide line of MAX unbalancing load means the unbalancing load, when the rotary table is used with support table in vertical application. The guide line figure will be different according to the servo motor, please refer to P.57 for more detail.

*3 Air Intensifying Booster system is available if the supplied air pressure is under 0.5MPa or the brake torque is required to increase. P.91

*4 CNC302T is semi-standard model.

*5 The table rotation speed when the motor rotates at 3000r/min. Depending on the application(unbalance of the jig,work) and the motor specification, the motor may not be able to rotate at 3000r/min. ★ αiF8/3000 motor can be mounted on CNC202T, 260T, 302T.

CNC202T, 260T, 302T



External dimensions depend on the type of the servo motor. Indicated dimensions are in case of FANUC. Please contact us for CAD files (2D:DXF, 3D:PARASOLID).

CNC202T

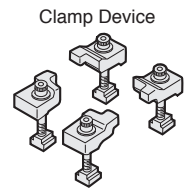
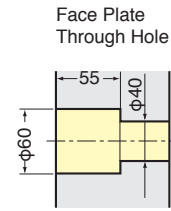
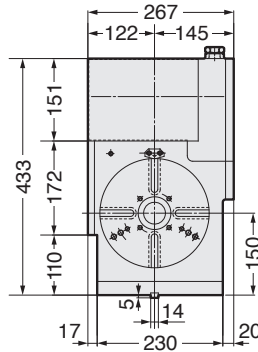
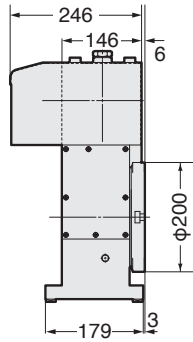

Air purge function is provided inside the motor cover as standard.

CNC260T

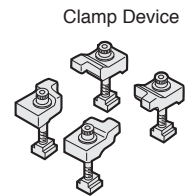
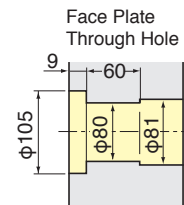
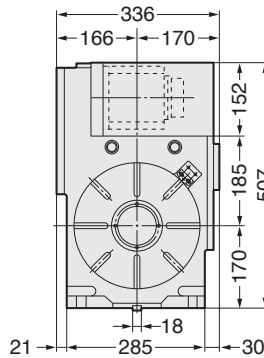
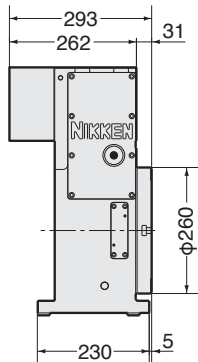

For the rotary table with pneumatic clamping, air purge function is provided inside the motor cover as standard.

CNC302T

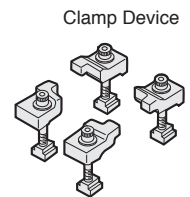
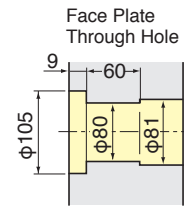
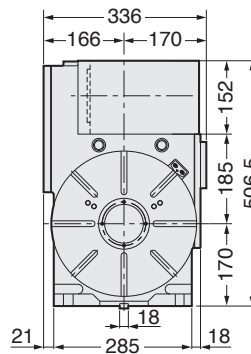
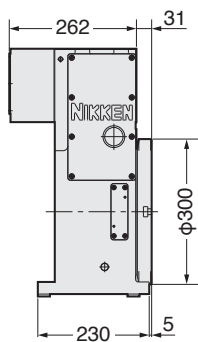

Center socket shown in photo is optional.



For the rotary table with pneumatic clamping, air purge function is provided inside the motor cover as standard.

Specification of the Top Side Mounted CNC Rotary Table



Photo with CNC302T without T slot.

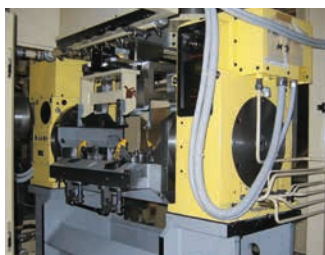

Synchronizers movement of 2 off CNC401T

Tubular roller bearing is installed against the thrust load. Therefore, when 2 rotary tables are faced on both side to synchronise movement, the system can be run without affecting the heat expansion of the rotary table.



CNC401T is installed on the pallet of the horizontal M/C.



CNC401T is installed on CNC600.



CNCB450T is used for the tilting axis table of 5AX-tilting rotary table.

TOP SIDE MOTOR MOUNTED CNC ROTARY TABLE

NIKKEN

CNC501T

■ Ideal for automation of small parts by mounting of jig holder

Also ideal for B-axis of general-purpose horizontal machining center. Figure at right shows example of pallet mounting.

Please specify A, B, C, D and E.

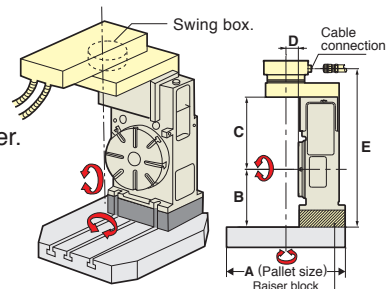

Option				Accessories					
ADD. AXIS	ACCURACY SPEC.	ROTARY JOINT	ULTRA PRECISION	SUPPORT TABLE	TAIL STOCK	SCROLL CHUCK	POWER CHUCK	CLAMP DEVICE	T-NUT
P.57	P.95	P.81	P.79	P.71	P.73	P.75	P.76	P.77	P.78

Specifications

Item / Code No.		CNC321T*3	CNC401T	CNC501T	CNC601T
Diameter of Table	φmm	320	400	500	600
Diameter of Spindle Hole	φmm	φ105H7	φ105H7	φ130H7	φ130H7
Center Height	mm	240	240	310	310
Width of T Slot	mm	12 ^{+0.018} ₀	14 ^{+0.018} ₀	14 ^{+0.018} ₀	14 ^{+0.018} ₀
Clamping System		Hydraulic	Hydraulic	Hydraulic	Hydraulic
Clamping Torque	N·m	1760	1760	4655	4655
Table Inertia at Motor Shaft	($\frac{GD^2}{4}$) kg·m ² ×10 ⁻³	2.0	2.0	9.0	8.8
Servo Motor	r/min	αiF12·2000	αiF12·2000	αiF22·2000	αiF22·2000
MIN. Increment		0.001°	0.001°	0.001°	0.001°
Rotation Speed	r/min	16.6	16.6	16.6	11.1
Total Reduction Ratio		1/120	1/120	1/120	1/180
Indexing Accuracy	sec	15	15	15	15
Net Weight	kg	220	245	495	525
MAX. Work Load on the Table	Vertical kg	250	250	400	400
	Horizontal kg	—	—	—	—
MAX. Thrust Load applicable on the Table	N	53100	53100	150000	150000
	*1 FXL N·m	2648	2648	5709	5709
	FXL N·m	3840	3840	16650	16650
Guide Line of MAX. Unbalancing Load	*2 N·m	100	100	200	200
MAX. Work Inertia	Vertical + ($\frac{GD^2}{4}$) kg·m ²	8.0	8.0	19	37
Driving Torque	N·m	576	576	576	864

*1 This is the strength of the worm wheel without brake. It is applied against dynamic cutting thrust.

*2 The guide line of MAX unbalancing load means the unbalancing load, when the rotary table is used with support table in vertical application. The guide line figure will be different according to the servo motor, please refer to P.57 for more detail.

*3 CNC321T is semi-standard model.

★ αiF22/4000 motor can be mounted on CNC321T, 401T.

★ Total reduction ratio of 1/180 is also available for CNC501T.

CNC321T, 401T, 501T, 601T



External dimensions depend on the type of the servo motor. Indicated dimensions are in case of FANUC. Please contact us for CAD files (2D:DXF, 3D:PARASOLID).

CNC321T

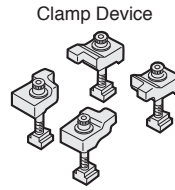
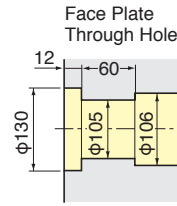
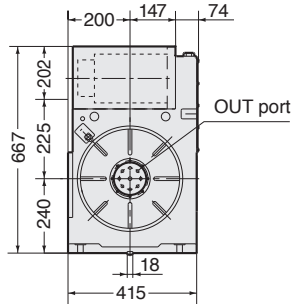
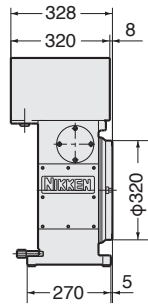

Rotary joint shown in layout is optional. In ports are located in back side.

CNC401T

★ Built-in type rotary joint can be mounted on CNC401 refer [P.89](#)

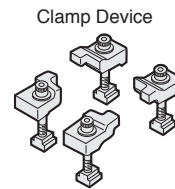
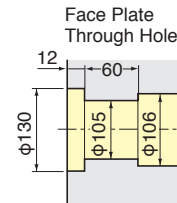
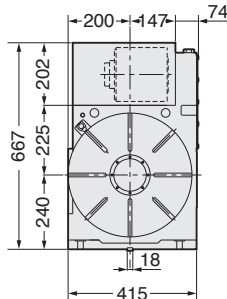
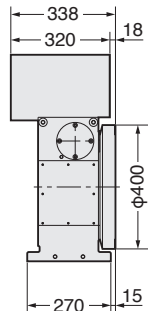

Center socket shown in photo is optional. In ports are located in back side.

CNC501T

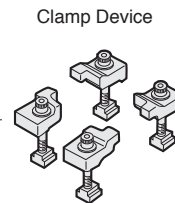
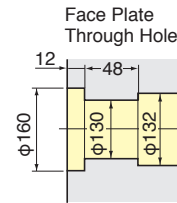
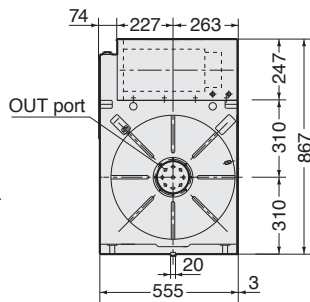
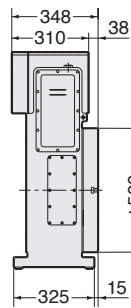

Rotary joint shown in layout is optional. In ports are located in back side.

CNC601T

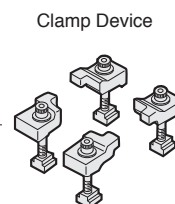
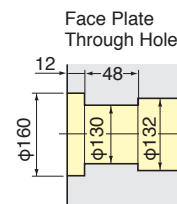
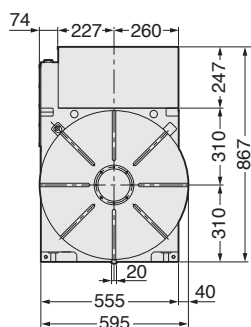
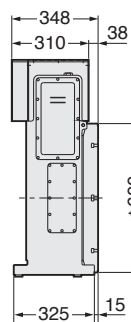

In ports are located in back side.

BACK SIDE MOTOR MOUNTED CNC ROTARY TABLE **NIKKEN**

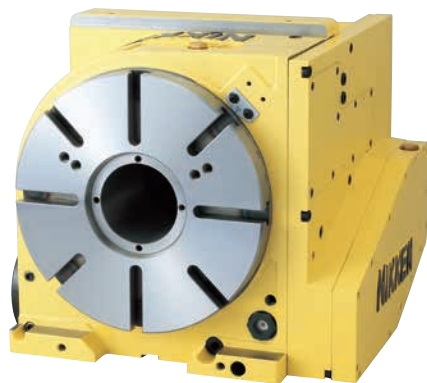









CNC260B

- Suitable for the machine which does not have so wide space for Y axis, such as the gantry type M/C or the M/C with splash guard
- Also compatible with rotary joints
- Select among pneumatic, hydraulic, and air-hydro clamping systems

Option				Accessories					
ADD. AXIS	ACCURACY SPEC.	ROTARY JOINT	ULTRA PRECISION	SUPPORT TABLE	TAIL STOCK	SCROLL CHUCK	POWER CHUCK	CLAMP DEVICE	T-NUT
P.57	P.95	P.81	P.79	P.71	P.73	P.75	P.76	P.77	P.78

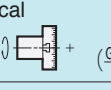
Specifications

Item / Code No.		CNC180B	CNC202B	CNC260B	CNC302B*4	CNC321B*4	CNC401B	
Diameter of Table	φmm	180	200	260	300	320	400	
Diameter of Spindle Hole	φmm	φ60H7 φ40	φ60H7 φ40	φ80H7	φ80H7	φ105H7	φ105H7	
Center Height	mm	180	180	170	170	230	230	
Width of T Slot	mm	12 ^{+0.018} ₀	12 ^{+0.018} ₀	12 ^{+0.018} ₀	12 ^{+0.018} ₀	12 ^{+0.018} ₀	14 ^{+0.018} ₀	
Clamping System		Pneumatic*3	Pneumatic*3	Pneumatic*3 / Hydraulic	Pneumatic*3 / Hydraulic	Hydraulic	Hydraulic	
Clamping Torque	N·m	303	303	588 / 1568	588 / 1568	1760	1760	
Table Inertia at Motor Shaft $\left(\frac{GD^2}{4}\right)$	kg·m ² ×10 ⁻³	0.4	0.4	1.7	1.8	7.0	7.0	
Servo Motor	r/min	αiF2·3000	αiF4·3000	αiF4·3000	αiF4·3000	αiF12·2000	αiF12·2000	
MIN. Increment		0.001°	0.001°	0.001°	0.001°	0.001°	0.001°	
Rotation Speed*5	r/min	33.3	33.3	25.0	25.0	22.2	22.2	
Total Reduction Ratio		1/90	1/90	1/120	1/120	1/90	1/90	
Indexing Accuracy	sec	±20	±20	20	20	15	15	
Net Weight	kg	56	60	145	150	240	270	
MAX. Work Load on the Table	Vertical 	kg	100	100	175	175	250	250
	Horizontal 	kg	—	—	—	—	—	—
MAX. Thrust Load applicable on the Table		N	18000	18000	42480	42480	53100	53100
	*1 	FX N·m	542	542	1442	1442	2648	2648
		FX N·m	690	690	2320	2320	3840	3840
Guide Line of MAX. Unbalancing Load	*2 	N·m	30	50	50	50	100	100
MAX. Work Inertia	Vertical 	$\left(\frac{GD^2}{4}\right)$ kg·m ²	0.4	1.0	3.2	3.2	6.4	6.4
Driving Torque		N·m	72	144	192	192	432	432

*1 This is the strength of the worm wheel without brake. It is applied against dynamic cutting thrust.

*2 The guide line of MAX unbalancing load means the unbalancing load, when the rotary table is used with support table. The guide line figure will be different according to the servo motor, please refer to  P.57 for more detail.

*3 Air Intensifying Booster system is available if the supplied air pressure is under 0.5MPa or the brake torque is required to increase.  P.91

*4 CNC302B, CNC321B is semi-standard model.

*5 The table rotation speed when the motor rotates at 3000r/min. Depending on the application(unbalance of the jig,work) and the motor specification, the motor may not be able to rotate at 3000r/min.

★ αiF4/5000 motor can be mounted on CNC180B. ★ αiF8/4000 motor can be mounted on CNC260B, 302B.

★ The air-hydraulic Booster is available, when the rotary table with hydraulic clamping system is used on the M/C without hydraulic source, please refer to  P.91.

CNC180B, 202B, 260B, 302B, 321B, 401B

NIKKEN

CNC

External dimensions depend on the type of the servo motor. Indicated dimensions are in case of FANUC. Please contact us for CAD files (2D:DXF, 3D:PARASOLID).

CNC180B

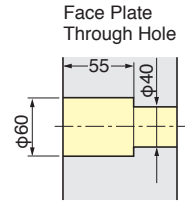
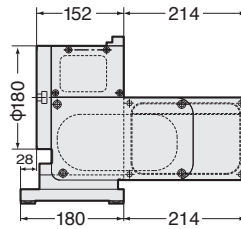
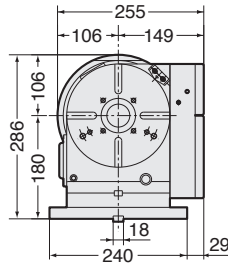

Clamp Device

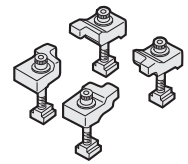

B BACK SIDE **WITH** FACE PLATE **AR21** CTRL

Air purge function is provided.

CNC202B

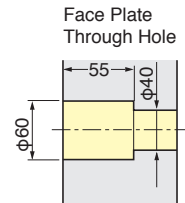
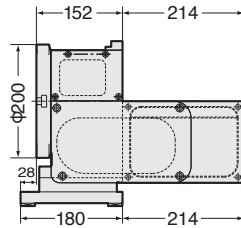
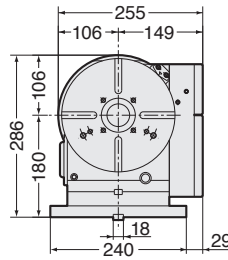

Clamp Device

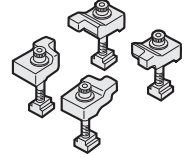

B BACK SIDE **WITH** FACE PLATE **AR21** CTRL

Air purge function is provided.

CNC260B

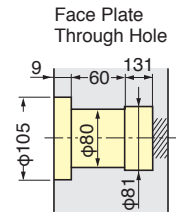
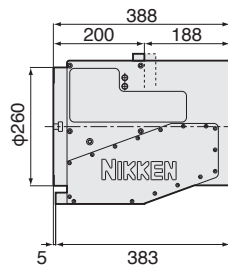
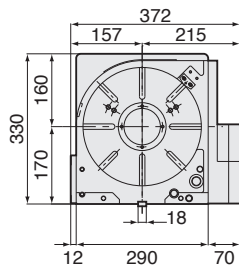
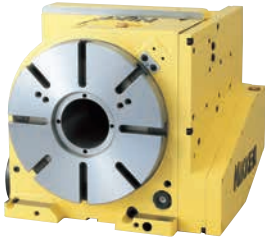

Clamp Device

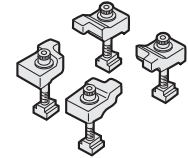

B BACK SIDE **WITH** FACE PLATE **AR21** CTRL

For the rotary table with pneumatic brake, air purge function is provided inside the motor cover as standard.

CNC302B

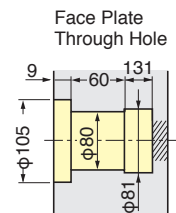
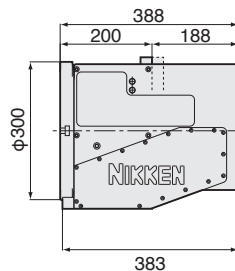
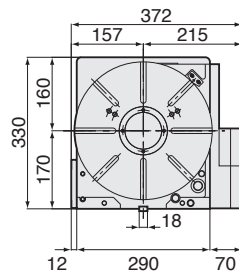
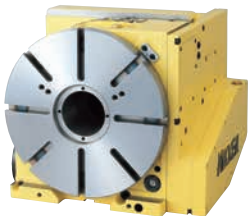

Clamp Device

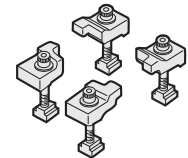

B BACK SIDE **WITH** FACE PLATE **AR21** CTRL

For the rotary table with pneumatic brake, air purge function is provided inside the motor cover as standard.

CNC321B, CNC401B

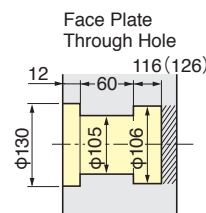
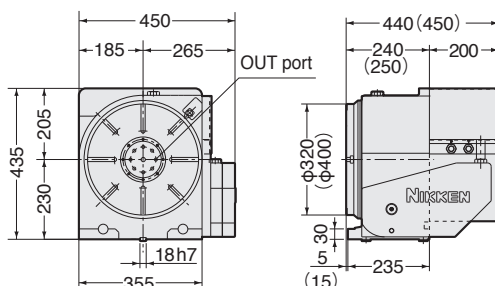

Clamp Device

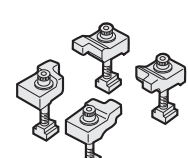

B BACK SIDE **WITH** FACE PLATE **AR21** CTRL

Center socket shown in photo & layout is optional.

IN ports are located in left side.
() : CNC401B

★ Built-in type rotary joint can be mounted on CNC321B & 401B, refer to P.81

BIG BORE CNC ROTARY TABLE

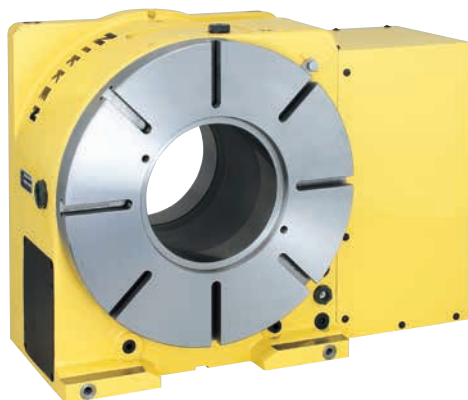
NIKKEN

CNCB 450

- Ideal for machining boring pipes for oil or natural gas
- Capable of cutting through-holes in work pieces
- Supports up to 20 + 1P rotary joint ports

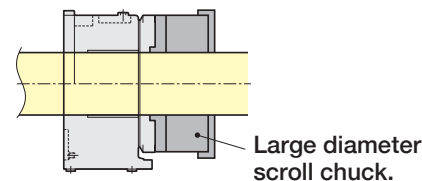







Example for the utilization
for large diameter bar work



Option				Accessories					
ADD. AXIS	ACCURACY SPEC.	ROTARY JOINT	ULTRA PRECISION	SUPPORT TABLE	TAIL STOCK	SCROLL CHUCK	POWER CHUCK	CLAMP DEVICE	T-NUT
P.57	P.95	P.81	P.79	P.71	P.73	P.75	P.76	P.77	P.78

Specifications

BIG BORE CNC Rotary Tables are all semi-standard models. Please contact us.

Item / Code No.		CNCB350	CNCB450	CNCB630
Diameter of Table	φmm	350	450	630
Diameter of Spindle Hole	φmm	φ154H7	φ205H7	φ345H7
Center Height	mm	230	280	380
Width of T Slot	mm	14	14	14
Clamping System		Hydraulic	Hydraulic	Hydraulic
Clamping Torque	N·m	3331	3870	6550
Table Inertia at Motor Shaft	$\left(\frac{GD^2}{4}\right) \text{ kg}\cdot\text{m}^2 \times 10^{-3}$	2.9	2.8	4.8
Servo Motor	r/min	αiF12·2000	αiF12·2000	αiF22·2000
MIN. Increment		0.001°	0.001°	0.001°
Rotation Speed	r/min	22.2	16.6	11.1
Total Reduction Ratio		1/90	1/120	1/180
Indexing Accuracy	sec	15	15	15
Net Weight	kg	245	330	750
MAX. Work Load on the Table	Vertical  kg	250	350	400
	Horizontal  kg	500	700	800
MAX. Thrust Load applicable on the Table	 N	5300	63720	250000
	*1  FXL N·m	2648	3531	5297
	 FXL N·m	3840	5990	33000
Guide Line of MAX. Unbalancing Load	*2  N·m	100	150	300
MAX. Work Inertia	Vertical  $\left(\frac{GD^2}{4}\right) \text{ kg}\cdot\text{m}^2$	6.4	17.0	40.0
Driving Torque	 N·m	432	576	1584

*1 This is the strength of the worm wheel without brake. It is applied against dynamic cutting thrust.

*2 The guide line of MAX unbalancing load means the unbalancing load, when the rotary table is used with support table in vertical application. The guide line figure will be different according to the servo motor, please refer to  P.57 for more detail.

★ Total reduction ratio of 1/180 is also available for CNCB450.

★ αiF22/4000 motor can be mounted on CNCB350, 450.

CNCB350, 450(T), 630



External dimensions depend on the type of the servo motor. Indicated dimensions are in case of FANUC. Please contact us for CAD files (2D:DXF, 3D:PARASOLID).

CNCB350

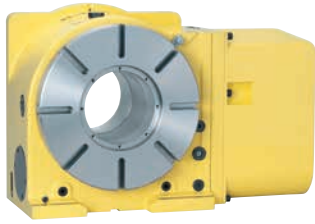

Ultra Big Bore ($\phi 154\text{mm}$) Specification

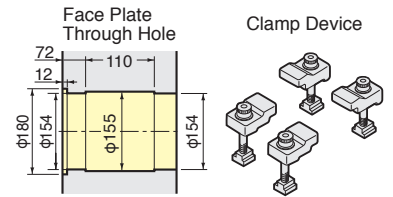
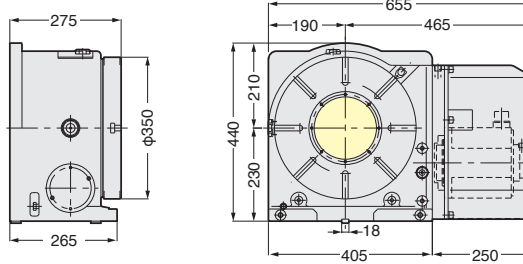

CNCB450

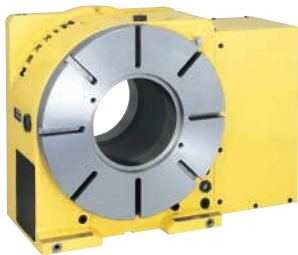

Ultra Big Bore ($\phi 205\text{mm}$) Specification

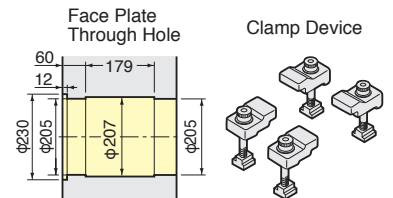
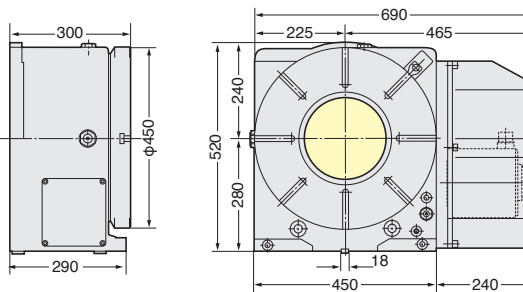

CNCB450T



Ultra Big Bore ($\phi 205\text{mm}$) Specification

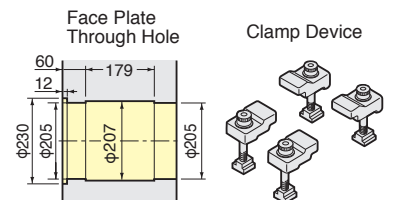
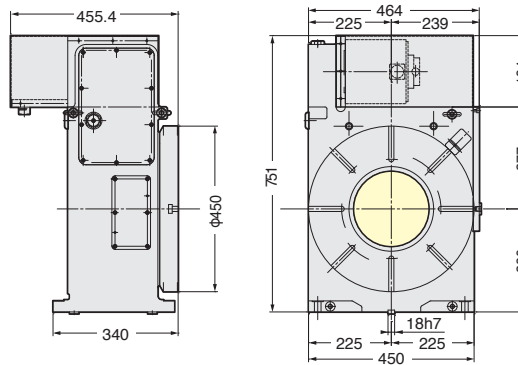

CNCB630

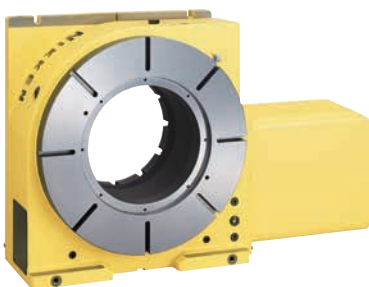

Ultra Big Bore ($\phi 345\text{mm}$) Specification

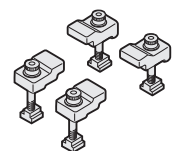
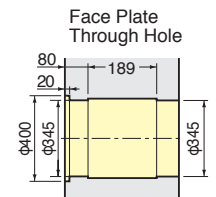
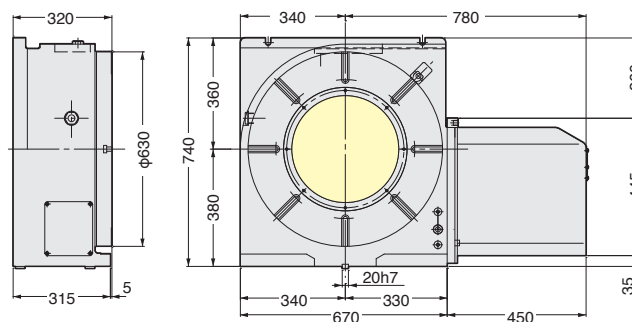

MULTI-SPINDLE CNC ROTARY TABLE

NIKKEN

CNC100-2W

- Multi-Spindle (2, 3 & 4 spindles) CNC rotary table series for rationalization of machining of small size work pieces ($\phi 3 \sim 100\text{mm}$)
- Max. number of spindles CNC100 : 4 spindles, CNC180 : 4 spindles, CNC202 : 4 spindles, CNC260 : 2 spindles. Please contact us
- Ideal for small items and mass-produced parts



Specifications

Multi-Spindle CNC Rotary Tables are all semi-standard models. Please contact us. () : High Speed type Please contact us.

Item / Code No.		CNC100-2W,-3W,-4W			CNC180-2W	CNC202-2W	CNC260-2W
Diameter of Table	ϕ mm	105			180	200	260
Diameter of Spindle Hole	ϕ mm	60H7 30			60H7 40	60H7 40	80H7
Number of spindles (Pitch)	mm	2,3,4×120			2×250	2×250	2×350
Center Height	mm	105			175	175	220
Width of T Slot	mm	16 ^{+0.018} ₀			12 ^{+0.018} ₀	12 ^{+0.018} ₀	12 ^{+0.018} ₀
Clamping System		Pneumatic*2			Pneumatic*2	Pneumatic*2	Pneumatic*2 / Hydraulic
Clamping Torque	N·m	147			303	303	588 / 1568
Table Inertia at Motor Shaft	$(\frac{GD^2}{4}) \text{ kg}\cdot\text{m}^2 \times 10^{-3}$	0.13	0.16	0.2	0.12	0.13	0.7
Servo Motor	r/min	α iF2·2000 (α iS4·2000)		α iF4·2000 (α iS8·2000)	α iF4·2000	α iF8·2000	α iF8·2000
MIN. Increment		0.001°			0.001°	0.001°	0.001°
Rotation Speed	r/min	11.1 (44.4)			22.2	22.2	16.6
Total Reduction Ratio		1/180 (1/45)			1/90	1/90	1/120
Indexing Accuracy	sec	±30		±45	±20	±20	20
Net Weight	kg	70	90	120	115	120	320
MAX. Work Load on the Table	Vertical	15			100	100	175
	Horizontal	30			200	200	350
MAX. Thrust Load applicable on the Table		3920			18000	18000	42480
	*1	275			542	542	1442
		98			690	690	2320
MAX. Work Inertia	Vertical	0.019			0.5	0.5	1.9
Driving Torque		72			72	144	192

*1 This is the strength of the worm wheel without brake. It is applied against dynamic cutting thrust.

*2 Air Intensifying Booster system is available if the supplied air pressure is under 0.5MPa or the brake torque is required to increase. P.91

★ Min. pitch between spindles CNC100 : 120mm, CNC180 : 250mm, CNC202 : 250mm, CNC260 : 350mm. Please contact us when the different pitch is required.

★ 4 spindles table to suit 2 spindles M/C is available.

★ 5 or 6 spindles CNC rotary table is also available.

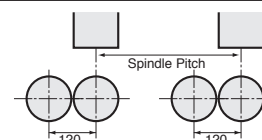

CNC100-2W, 3W, 4W, CNC180-2W, CNC202-2W, CNC260-2W



External dimensions depend on the type of the servo motor. Indicated dimensions are in case of FANUC. Please contact us for CAD files (2D:DXF, 3D:PARASOLID).

CNC100-2W

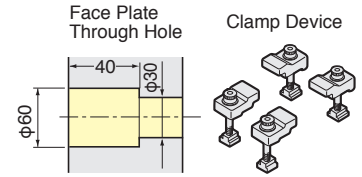
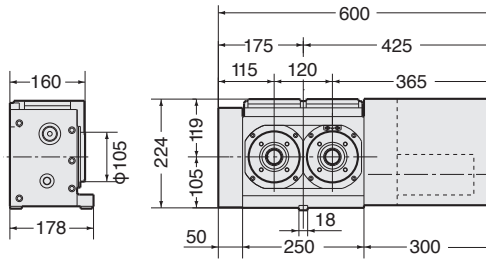

Air purge function is provided inside the motor cover as standard.
If you need a knock hole for positioning or a key way on the table surface, please contact us.

CNC100-3W

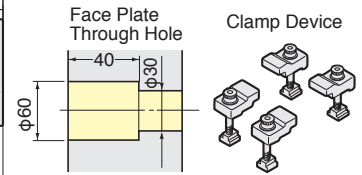
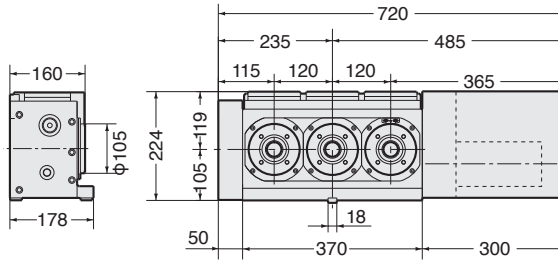

Air purge function is provided inside the motor cover as standard.
If you need a knock hole for positioning or a key way on the table surface, please contact us.

CNC100-4W

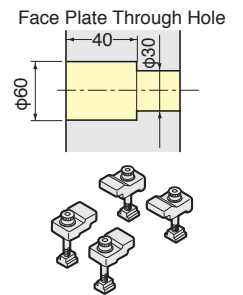
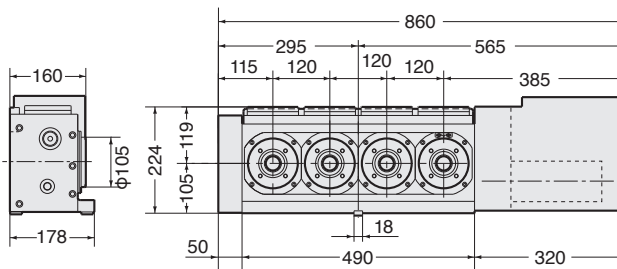

Air purge function is provided inside the motor cover as standard.
If you need a knock hole for positioning or a key way on the table surface, please contact us.

CNC180-2W, CNC202-2W

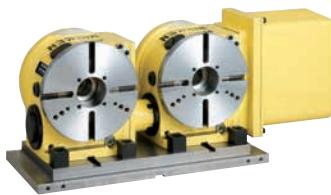

CNC202-2W

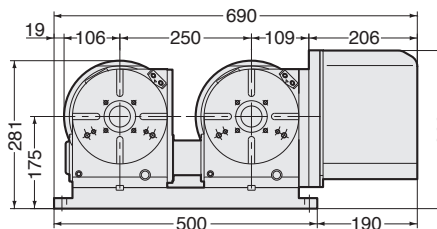

CNC180-2W

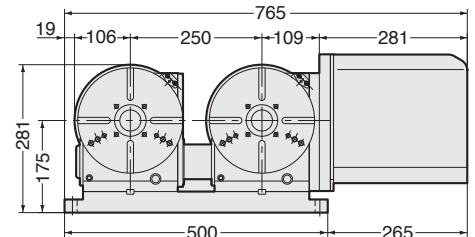

CNC202-2W



Air purge function is provided inside the motor cover as standard.

CNC260-2W

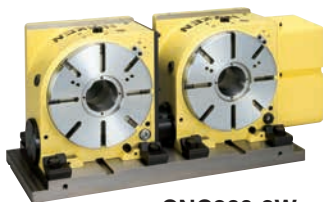

CNC260-2W

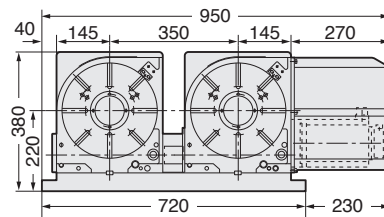

For the rotary table with pneumatic clamping, air purge function is provided inside the motor cover as standard.

CNC260-2W-325T



CNC260-2W-325T

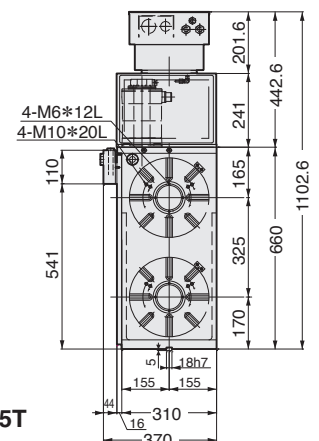

NCT

CNC ROTARY TABLE

New

HIGH CLAMPING TORQUE COMPACT CNC ROTARY TABLE

NCT

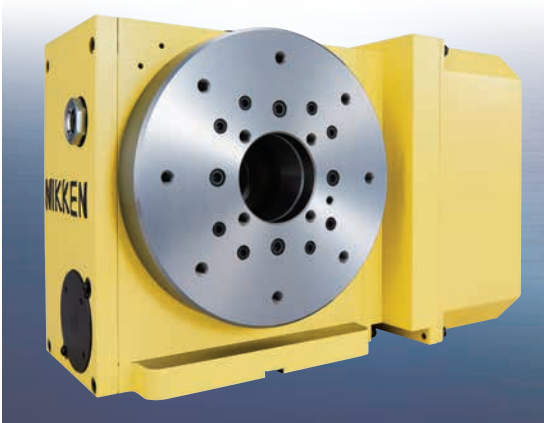

Small but Strong NCT200

Option				Accessories					
ADD. AXIS	ACCURACY SPEC.	ROTARY JOINT	ULTRA PRECISION	SUPPORT TABLE	TAIL STOCK	SCROLL CHUCK	POWER CHUCK	CLAMP DEVICE	T-NUT
P.57	P.95	P.81	P.79	P.71	P.73	P.75	P.76	P.77	P.78

900Nm

Super-high Clamping System

Reliable indexing accuracy enhances profitability

Super-high Clamping torque 900Nm can be generated by air supply only. Strong clamping torque and better indexing accuracy enhance productivity.

25%UP

High Rigidity of New Driving System

Maintain high accuracy over the long term Reduce the total maintenance cost

Redesigning the driving system, the rigidity increases 25%. High durability of the mechanism is allowed to maintain high accuracy and to accomplish high precision machining operation over the long term.

High Speed

Z Type is also Available

Reducing cycle time enhances productivity

High speed Z type is also available. Setting up gear ratio 1/2 is allowed rotation speed to be double.

Great Customization

Without faceplate models are now available. A variety of options enhance the great utility for your applications.

Face Plate	Rotary Joint	Angular Plate for Trunnion Systems	Support Table
<p>NCT200E</p> <p>W/O Face Plate</p>	<p>Flange plate Type 6 Port</p> <p>Cylinder Type 6+1 Port</p>	<p>Offset 50mm</p> <p>Offset 20mm</p>	<p>With Clamping System</p> <p>TAT-105N-135</p> <p>W/O Clamping System</p> <p>CST-100-135</p> <p>Ultra-Slim Model</p> <p>TAS-100N</p>
<p>NCT200</p> <p>With Face Plate</p>		<p>Offset 50mm</p> <p>Offset 20mm</p>	

Specifications

Item / Code No.	With Face Plate		W/O Face Plate	
	Standard	High Speed	Standard	High Speed
Right Hand Mounted Moter	NCT200	NCTZ200	NCT200E	NCTZ200E
Left Hand Mounted Moter	NCT200L	NCTZ200L	NCT200EL	NCTZ200EL
Diameter of Table ϕ mm	200	200	130	130
Diameter of Spindle Hole ϕ mm	$\phi 60_{H7} \phi 40$	$\phi 60_{H7} \phi 40$	$\phi 60_{H7} \phi 40$	$\phi 60_{H7} \phi 40$
Center Height mm	135	135	135	135
Clamping System	Pnematic*3	Pnematic*3	Pnematic*3	Pnematic*3
Clamping Torque N·m	900	900	900	900
Table Inertia at Motor Shaft $\text{kg}\cdot\text{m}^2 \times 10^{-3}$	0.1	0.1	0.1	0.1
Servo Motor $(\frac{GD^2}{4})$ r/min	$\alpha iF4\cdot 3000$	$\alpha iF4\cdot 3000$	$\alpha iF4\cdot 3000$	$\alpha iF4\cdot 3000$
MIN. Increment	0.001	0.001	0.001	0.001
Rotation Speed*4 r/min	33.3	66.6	33.3	66.6
Total Reduction Ratio	1/90	1/45	1/90	1/45
Indexing Accuracy sec	± 20	± 20	± 20	± 20
Net Weight kg	65	65	62	62
MAX. Work Load on the Table	Vertical kg	100	100	100
	Horizontal kg	200	200	200
MAX. Thrust Load applicable on the Table	N	18000	18000	18000
	*1 FXL N·m	677	677	677
	FXL N·m	690	690	690
Guide Line of MAX. Unbalancing Load *2 N·m	60	30	60	30
MAX. Work Inertia $(\frac{GD^2}{4})$ $\text{kg}\cdot\text{m}^2$	1.1	0.5	1.1	0.5
Driving Torque N·m	151	121	151	121

*1 This is the strength of the worm wheel without face plate clamping. It is applied against dynamic cutting thrust.

*2 The guide line of MAX unbalancing load means the unbalancing load, when the rotary table is used with support table in vertical application. The guide line figure will be different according to the servo motor, please refer P.57 for more detail.

*3 Air Intensifying Booster system is available if the supplied air pressure is under 0.5MPa or the brake torque is required to increase. P.91

*4 The table rotation speed when the motor rotates at 3000r/min. Depending on the application(unbalance of the jig,work) and the motor specification, the motor may not be able to rotate at 3000r/min.

★Driving torque means the torque at MAX. rotation speed after acceleration. Driving torque is almost constant and independent from the load except unbalancing load is applied.

★Standard faceplate is without T slot. T slot is available as an option. Please contact us.

★6" (Chuck plate : X-6B) and 7" (Chuck plate : X-7A) can be mounted for Face Plate with T slots.

DIMENSIONS OF NCT200



NCT200 (With Face Plate)



(Photo) NCT200FA

Face Plate Through Hole

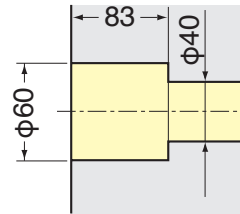

Clamp Device

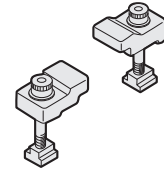

Left Hand : NCT200LFA

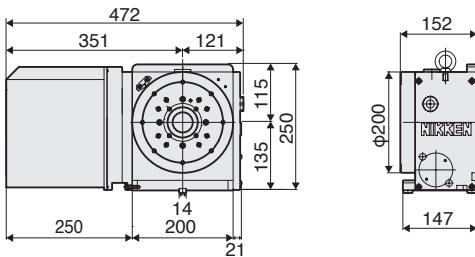

Right Hand : NCT200FA

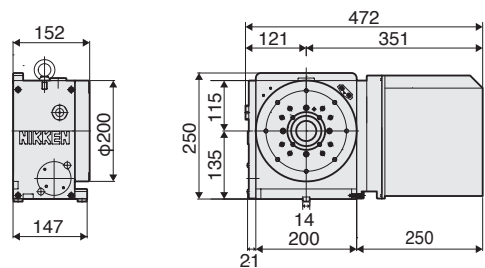

Left Hand : With Cylinder type Rotary Joint

NCT200L+Clinder type Rotary Joint(6+1 Ports)
RT-NC200SD-6+1-L*1

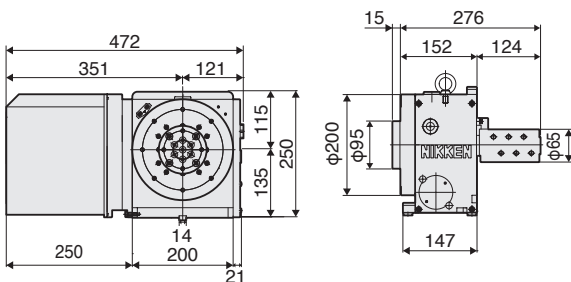

Right Hand : With Cylinder type Rotary Joint

NCT200+Clinder type Rotary Joint(6+1 Ports)
RT-NC200SD-6+1-R*1

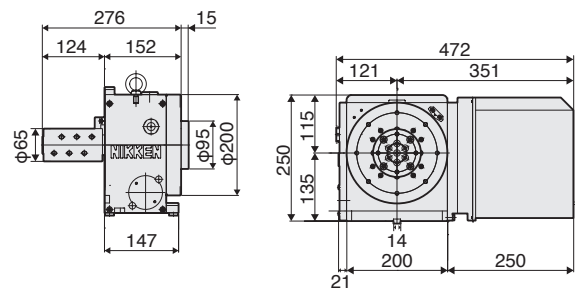

Left Hand : With Flange Plate type Rotary Joint

NCT200L+Flange Plate type Rotary Joint(6 Ports)
RN-NC200SD-6+N-F*1

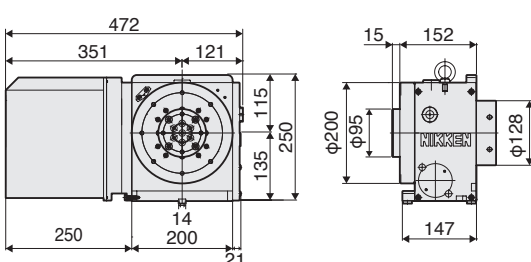

Right Hand : With Flange Plate type Rotary Joint

NCT200+Flange Plate type Rotary Joint(6 Ports)
RN-NC200SD-6+N-F*1

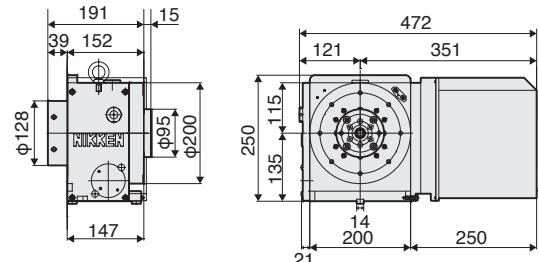

External dimensions depend on the type of the servo motor. Indicated dimensions are in case of FANUC. Please contact us for CAD files (2D:DXF, 3D:PARASOLID).

DIMENSIONS OF NCT200E



NCT200E (W/O Face Plate)

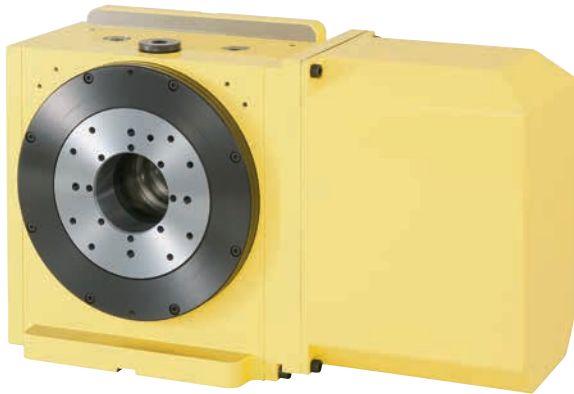

(Photo) NCT200EFA

Face Plate Through Hole

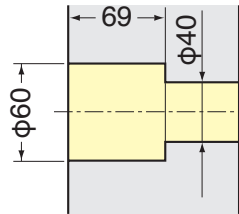

Clamp Device

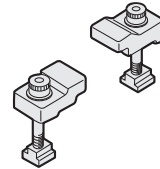

Left Hand : NCT200ELFA

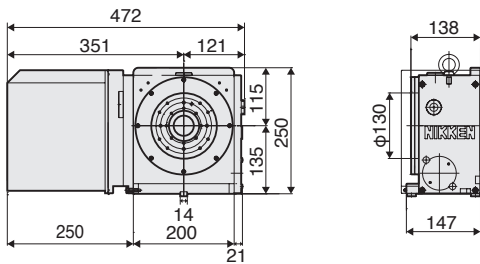

Right Hand : NCT200EFA

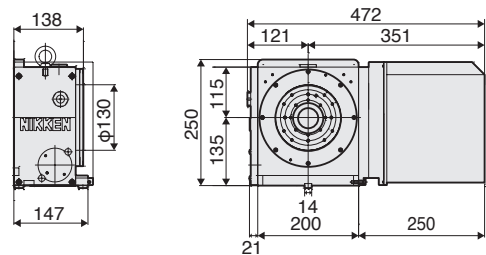

Left Hand : With Cylinder type Rotary Joint

NCT200EL+Clinder type Rotary Joint(6+1 Ports)
RT-NC20ESD-6+1-L*1

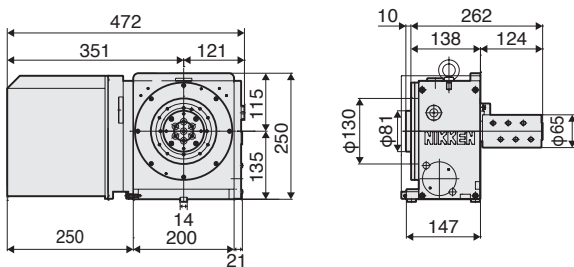

Right Hand : With Cylinder type Rotary Joint

NCT200E+Clinder type Rotary Joint(6+1 Ports)
RT-NC20ESD-6+1-R*1

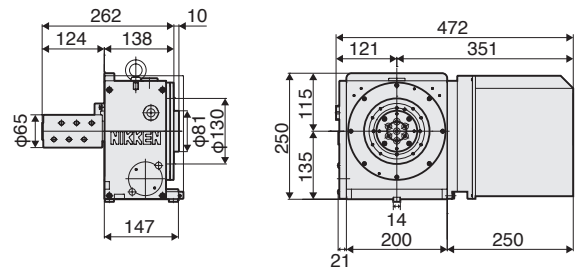

Left Hand : With Flange Plate type Rotary Joint

NCT200EL+Flange Plate type Rotary Joint(6 Ports)
RN-NC20ESD-6+N-F*1

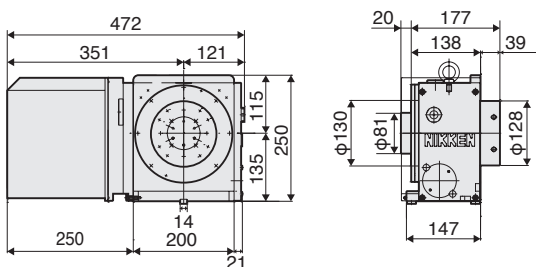

Right Hand : With Flange Plate type Rotary Joint

NCT200E+Flange Plate type Rotary Joint(6 Ports)
RN-NC20ESD-6+N-F*1

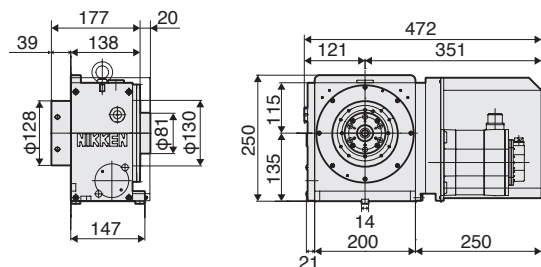

External dimensions depend on the type of the servo motor. Indicated dimensions are in case of FANUC. Please contact us for CAD files (2D:DXF, 3D:PARASOLID).

*1 RT- / RN is Code No. of Rotary Joint.

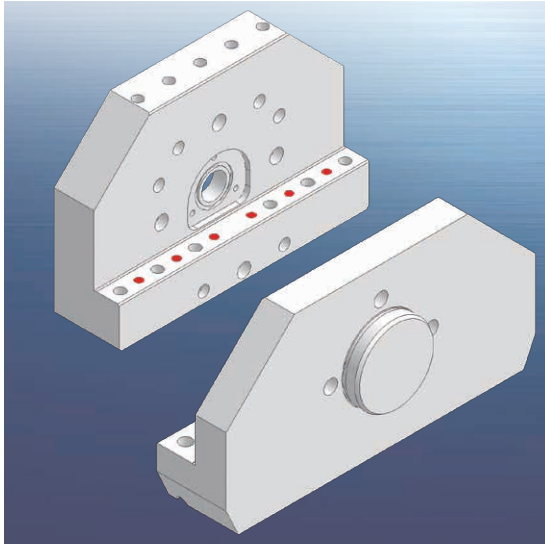

Model without faceplate: Custom Angular plates for use with the NCT200E. When combined with the NCT200E, they enable configuration of compact trunnion applications that maximize space inside the machine.

Trunnion Applications Utilize the NCT's High Rigidity and Powerful Clamping Capability for More Efficient Utilization of Limited Space.

The NCT200 series, which can reliably drive trunnion applications with its powerful clamping capability and high rigidity exceeding the norm for this product class, is now provided with angle plates as a standard accessory. When combined with the NCT200E without faceplate, they allow application configuration that utilizes space inside the machine to the maximum.

Ex.) Trunnion Application with NCT200E and Angular Plates

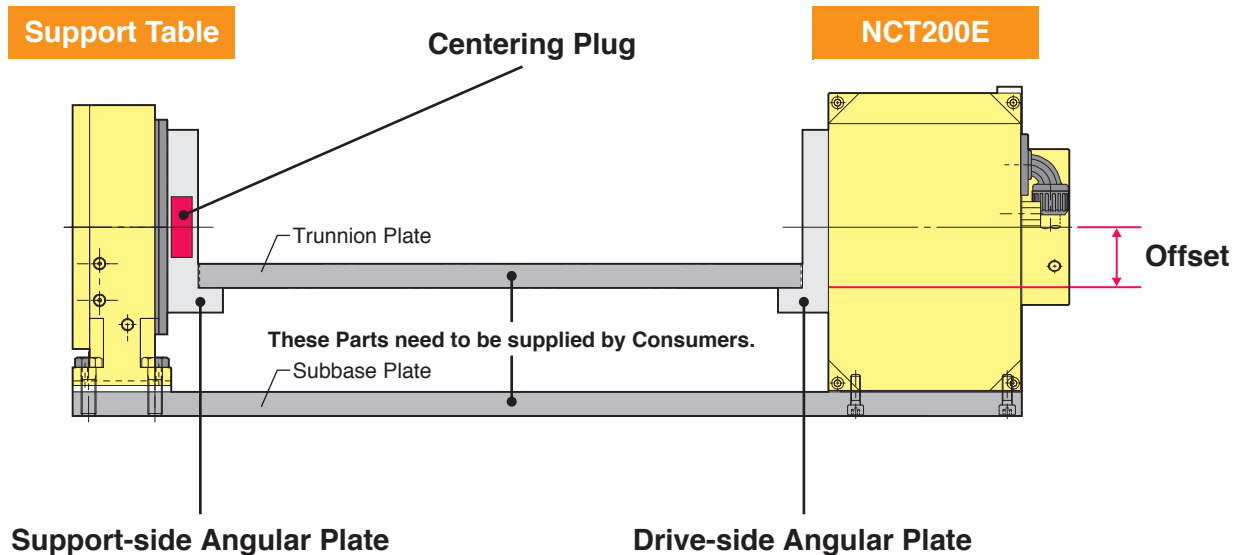

Lineup Of Two Types for Internal or External Rotary Joints

A lineup of two types of drive-side angle plate is available for use in combination with the NCT200E to match the rotary joint specification. Specify the type of angle plate you require according to the components or applications.

20 mm / 50 mm Selectable Offset

In addition, a lineup of two offset specifications is available for both the drive-side Angular plate and support-side Angular plate. This allows you to configure the optimal application to match the component size.

SPECIFICATION OF ANGULAR PLATE FOR NCT200E



Explanation of the Code No.)

AP-NC200E-SD-RT6+1-20

Angular Plate Code No. Product Code No. SD... Standard SP... Special Number of Ports of Rotary Joint RT... Cylinder type RN... Flange Plate type N ... Non (Support-side Only) Offset 20 ... 20mm 50 ... 50mm

Drive-side

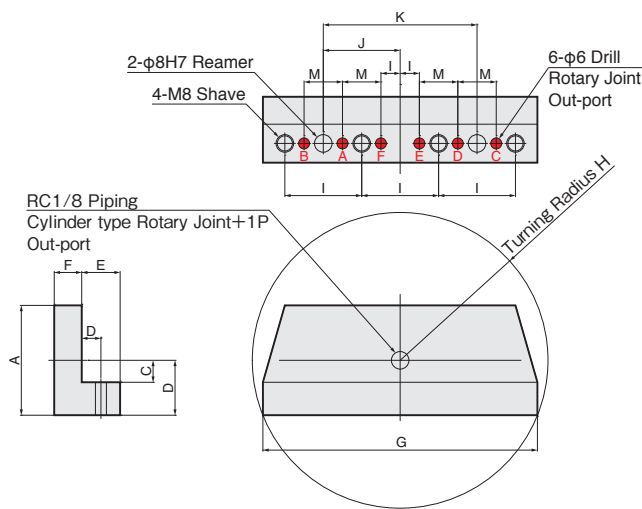

Support-side

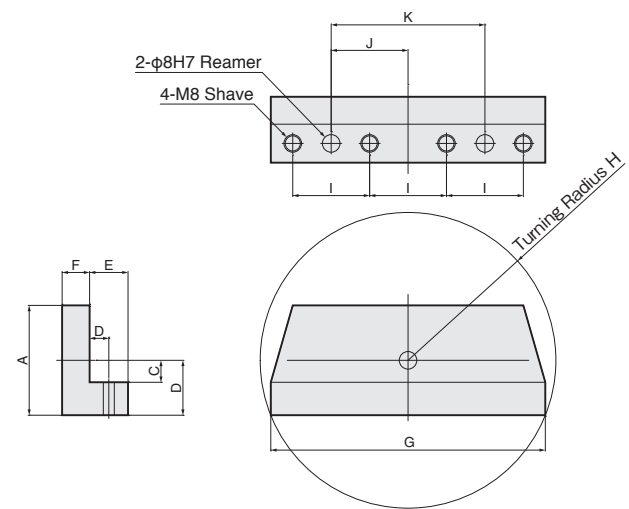

Specifications

Subject Models		type	Offset	Code No.	A	B	C	D	E	F	G	H	I	J	K	
Drive-side	NCT200E	Cylinder type Rotary Joint Ports Including	20mm	AP-NC200E-SD-RT6+1-20	133	53	20	11	20	25	200	107	60	60±0.01	120±0.01	
			50mm	AP-NC200E-SD-RT6+1-50	150	70	50									114
		Flange Plate type Rotary Joint Ports Including	20mm	AP-NC200E-SD-RN6-20	133	53	20									113
			50mm	AP-NC200E-SD-RN6-50	150	70	50									114
Support-side	TAS-100N	with Centering Plug	20mm	AP-TAS100-SD-N-20	105	53	20	16	25	20	200	113	60	60±0.01	120±0.01	
			50mm	AP-TAS100-SD-N-50	122	70	50									114
	TAT-105N-135	with Centering Plug	20mm	AP-TAT105-SD-N-20	105	53	20									113
			50mm	AP-TAT105-SD-N-50	122	70	50									114

The rotary joint is not included in the set of the angular plate. Please order both angular plate and rotary joint.



Check point for trunnion fixture

① When installing the table onto the sub-base, measure and check as follows.

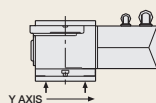

Parallelism between table & sub-base is recommended within 0.01mm

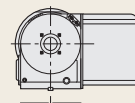

Difference between table center and sub-base center is recommended within 0.02mm

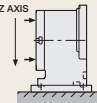

Squareness of table is recommended within 0.02mm

② Install the table & support table onto the M/C as follows.

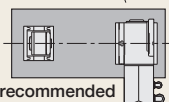

Center lines are recommended within 0.02mm

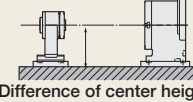

Difference of center height is recommended within 0.01mm

③ Trunnion fixture is recommended to be aligned as follows.

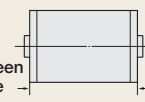

Center of both side are recommended within 0.01mm



Squareness is important

⚠ After installing the trunnion fixture jig, if you want to drive it with manual pulse generator, the magnification of the manual pulse generator should be X1. Never drive at X10 or X100.

Squareness between center line & these faces is important

NSV | ROTARY HIRTH COUPLING INDEX



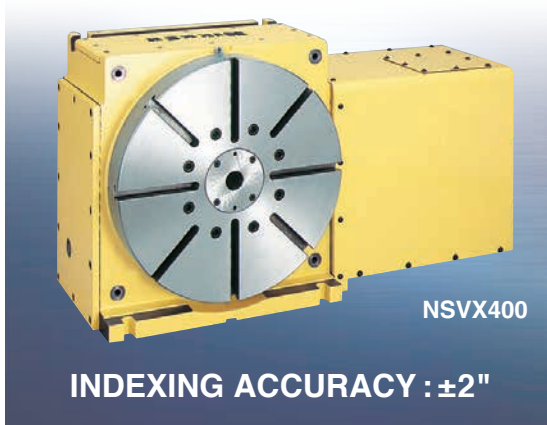





NSV



- Ideal for deep cutting of highly rigid material
- Indexing Accuracy : $\pm 2''$
- No Lifting up of Table at Indexing Time.
(Built-in 3 pieces of Hirth Coupling)

Option				Accessories					
ADD. AXIS	ACCURACY SPEC.	ROTARY JOINT	ULTRA PRECISION	SUPPORT TABLE	TAIL STOCK	SCROLL CHUCK	POWER CHUCK	CLAMP DEVICE	T-NUT
P.57	P.95	P.81	P.79	P.71	P.73	P.75	P.76	P.77	P.78

Specifications

Item / Code No.		NSVZ180	NSVZ300	NSVX400	NSVX500	NSVX400T
Diameter of Table	ϕ mm	180	300	400	500	400
Diameter of Spindle Hole	ϕ mm	$\phi 60_{H7} \phi 30$	$\phi 60_{H7} \phi 52$	$\phi 80_{H7}$	$\phi 80_{H7}$	$\phi 80_{H7}$
Center Height	mm	135	170	240	310	240
Width of T Slot	mm	$12^{+0.018}_0$	$12^{+0.018}_0$	$14^{+0.018}_0$	$14^{+0.018}_0$	$14^{+0.018}_0$
Clamping System		Hydraulic	Hydraulic	Hydraulic	Hydraulic	Hydraulic
Clamping Torque	N·m	910	2155	5880	5880	5880
Table Inertia at Motor Shaft ($\frac{GD^2}{4}$)	$\text{kg}\cdot\text{m}^2 \times 10^{-3}$	0.11	0.16	2.9	3.9	2.9
Servo Motor	r/min	α iF2·2000	α iF4·2000	α iF12·2000	α iF12·2000	α iF12·2000
MIN. Increment		1°	1°	1°*/0.001°	1°*/0.001°	1°*/0.001°
Rotation Speed	r/min	11.1	11.1	22.2	16.6	16.6
Total Reduction Ratio		1/180	1/180	1/90	1/120	1/120
Indexing Accuracy	sec	± 3	± 2	$\pm 2^*$	$\pm 2^*$	$\pm 2^*$
Net Weight	kg	60	150	325	410	350
MAX. Work Load on the Table	Vertical  kg	50	150	250	250	250
	Horizontal  kg	100	300	500	500	—
MAX. Thrust Load applicable on the Table	 N	23520	39200	58800	58800	58800
	*1  FXL N·m	911	2156	5880	5880	5880
	 FXL N·m	569	1421	3920	3920	3920
Guide Line of MAX. Unbalancing Load	*2  N·m	30	30	100	100	—
MAX. Work Inertia	Vertical  ($\frac{GD^2}{4}$) $\text{kg}\cdot\text{m}^2$	0.14	1.0	6.4	6.4	11.5
Driving Torque	 N·m	—	—	432	576	576

*1 This is the strength of the clamping by the hirth coupling.

*2 The guide line of MAX unbalancing load means the unbalancing load, when the rotary table is used with support table in vertical application. The guide line figure will be different according to the servo motor, please refer to  P.57 for more detail.

★ NSVZ series are indexing table which is indexable at each 1°.

★ NSVX series are rotary and indexing table which clamped by hirth coupling (of high precision & high rigidity) at each 1°, also perform min. command incremental at 0.001° and profile milling.

★ α iF4/5000 motor can be mounted on NSVZ180.

★ Please be careful that the centralizing of work piece or jig fixture should be done after indexing, not rotating.

★ The solenoid valve is installed inside the table for the indexing table with NIKKEN controller. The solenoid valve must be installed at the hydraulic tank for the indexing table of the additional axis control.

NSVZ180, 300, NSVX400, 400T, 500



No lift (Three pieces of Hirth Coupling)

Three pieces of 360 division precision hirth coupling ensures smooth and fast indexing without table lifting.

- 3-piece Hirth coupling developed in-house by NIKKEN

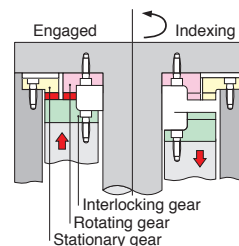

External dimensions depend on the type of the servo motor. Indicated dimensions are in case of FANUC. Please contact us for CAD files (2D:DXF, 3D:PARASOLID).

NSVZ180

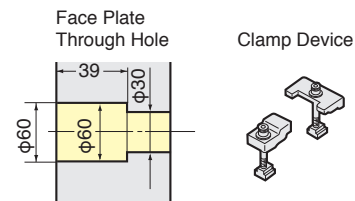
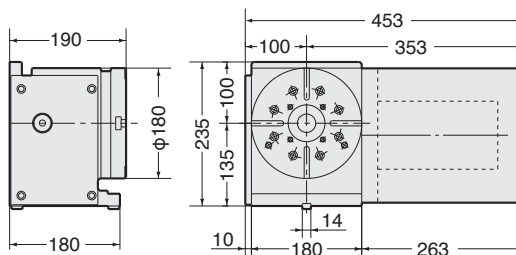

NSVZ300

Photo with center socket. (optional)

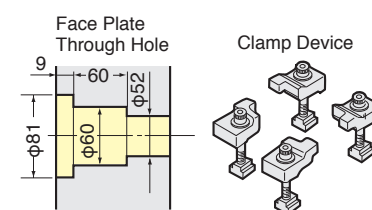
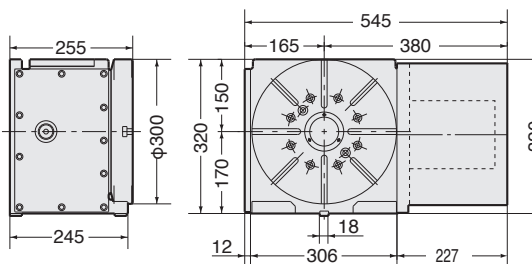

NSVX400

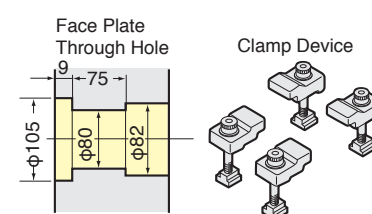
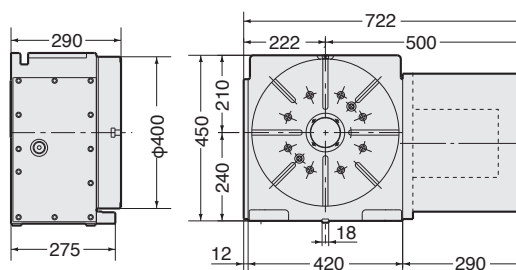

NSVX400T

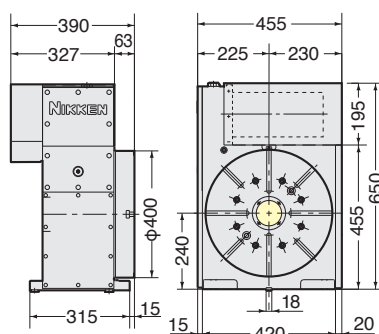
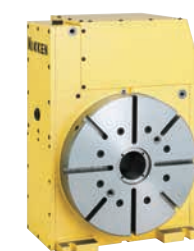

NSVX500

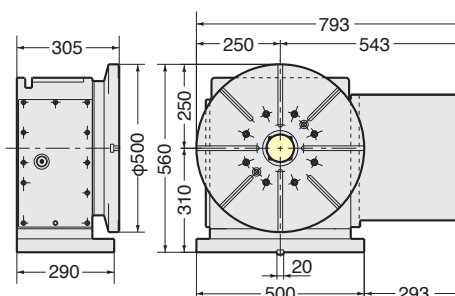
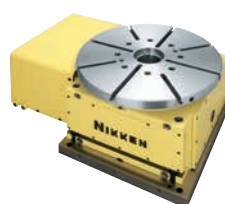
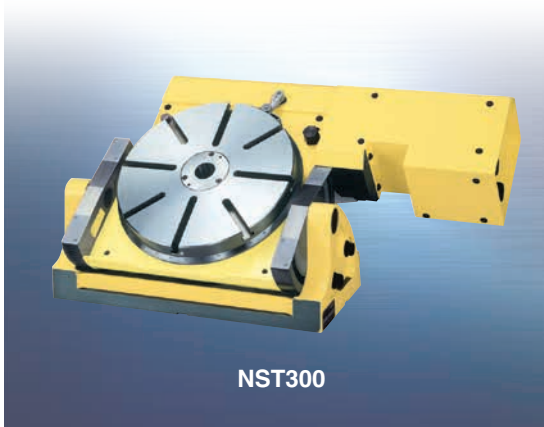

Photo : for horizontal use.
Please contact us for external dimension.

NST | MANUAL TILTING ROTARY TABLE

- Table can be tilted at 0°~90° manually
- Indexing is CNC controlled so that it can be adapted to all kinds of machining
- Suitable for wide variety of applications thanks to numerical tilting axis control



NST300

Option		Accessories				
ADD. AXIS	ACCURACY SPEC.	TAIL STOCK	SCROLL CHUCK	POWER CHUCK	CLAMP DEVICE	T-NUT
P.57	P.95	P.73	P.75	P.76	P.77	P.78

Specifications

Item / Code No.		NST250	NST300	NST500
Diameter of Table	φmm	250	300	500
Diameter of Spindle Hole	φmm	φ60H7 φ52	φ60H7 φ60	φ75H7 φ61.5
Center Height	mm	155	208	288
Width of T Slot	mm	12 ^{+0.018} ₀	12 ^{+0.018} ₀	14 ^{+0.018} ₀
Clamping System		Pneumatic*2	Pneumatic*2	Pneumatic*2
Clamping Torque	N·m	147	196	196
Table Inertia at Motor Shaft	($\frac{GD^2}{4}$) kg·m ² ×10 ⁻³	0.39	0.59	0.69
Servo Motor	r/min	α iF2·2000	α iF4·2000	α iF8·2000
MIN. Increment		0.001°	0.001°	0.001°
Rotation Speed	r/min	16.6	11.1	5.5
Total Reduction Ratio		1/120	1/180	1/360
Indexing Accuracy	sec	20	20	20
Net Weight	kg	75	135	320
MAX. Work Load on the Table	90°	50	100	200
	Horizontal	100	300	500
MAX. Thrust Load applicable on the Table		17500	31860	75000
	*1	603	903	2884
		770	2010	8330
MAX. Work Inertia	90°	1.35	3.37	14.70
Driving Torque		144	288	1152

*1 This is the strength of the worm wheel without brake. It is applied against dynamic cutting thrust.

*2 Air Intensifying Booster system is available if the supplied air pressure is under 0.5MPa or the brake torque is required to increase. P.91

★ αiF4 motor can be mounted on NST250.

★ αiF8/3000 motor can be mounted on NST300.

NST250, 300, 500



External dimensions depend on the type of the servo motor. Indicated dimensions are in case of FANUC. Please contact us for CAD files (2D:DXF, 3D:PARASOLID).

NST250

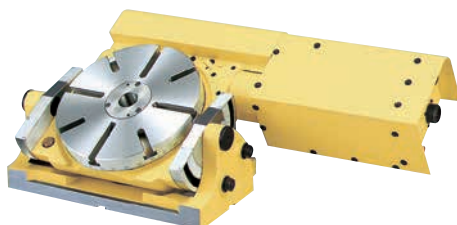

Center socket shown in photo is optional.

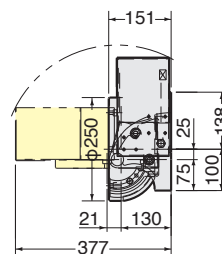
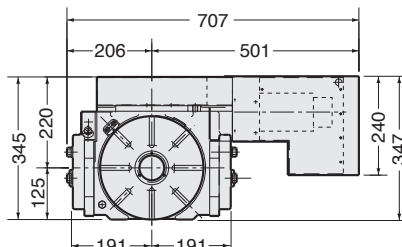

Center height at 90° : 155mm

Face Plate Through Hole

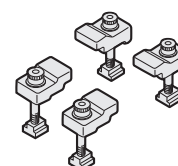
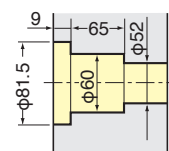

Clamp Device



Guide key width: 18mm
Table height in horizontal position: 151mm

NST300



Center socket shown in photo is optional.

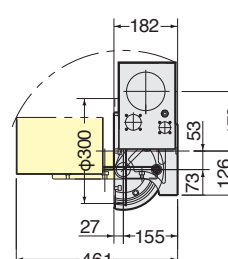
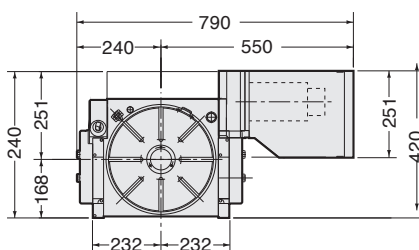

Center height at 90° : 208mm

Face Plate Through Hole

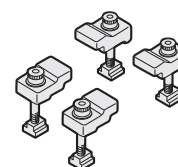
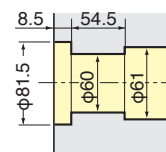

Clamp Device



Guide key width: 18mm
Table height in horizontal position: 182mm

NST500



Center socket shown in photo is optional.

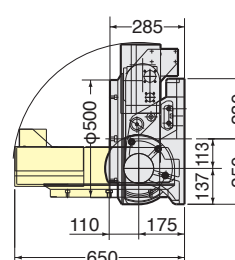
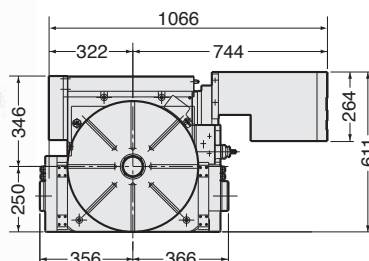

Center height at 90° : 288mm

Face Plate Through Hole

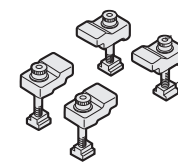
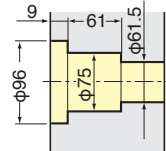

Clamp Device



Guide key width: 18mm
Table height in horizontal position: 285mm

5AX

TILTING ROTARY TABLE

New

THE SMALLEST TILTING CNC ROTARY TABLE FOR COMPACT MACHINES

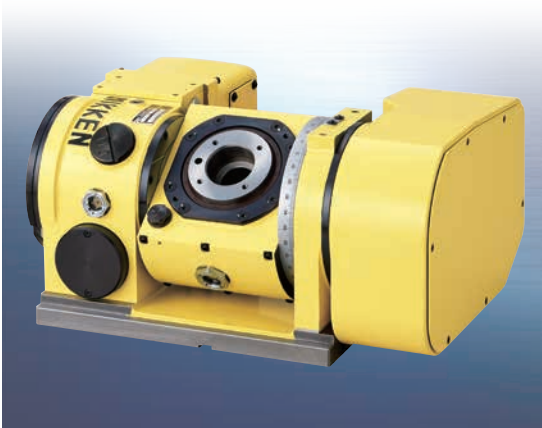

Ultra Compact Tilting Rotary Table

5AX-100 PAT.

Option				Accessories			
ADD. AXIS	ACCURACY SPEC.	ROTARY JOINT	ULTRA PRECISIO	TAIL STOCK	POWER CHUCK	CLAMP DEVICE	T-NUT
P.57	P.95	P.81	P.79	P.73	P.76	P.77	P.78

Minimum & Lightest Weight

The Smallest and Lightest 5AX

Demonstrates the true worth of a compact machining center with limited machining space.

With a body width of 466mm and product weight of 84 kg, the 5AX series is the smallest and lightest tilting rotary table in NIKKEN's history. It is an ideal counterpart to products such as the BT30 compact machining center. It allows you to secure more machining space than was possible with earlier models.

Tilting Axis 600Nm

Powerful braking system with double clamping sleeve type PAT. Tilt-axis with Air-hydraulic unit as Standard Equipment.

Astoundingly powerful clamping capability in spite of compact body.

For machines with no hydraulic power source, the tilt-axis is equipped with an air-hydro unit that provides powerful hydraulic clamping using only an air supply. In spite of its compact body, it delivers an astounding 600 Nm of clamping power, enabling high positioning accuracy for highly precise machining.

Extensive Lineup of Attachments

This extensive attachment lineup from NIKKEN allows machining of a wide variety of work pieces.



Jig Plate



Scroll Chuck



Center Socket

High-precision 5-axis machining of precision electronic devices such as smartphones, automobile parts, etc. can be accomplished using a compact machining center.



Impeller

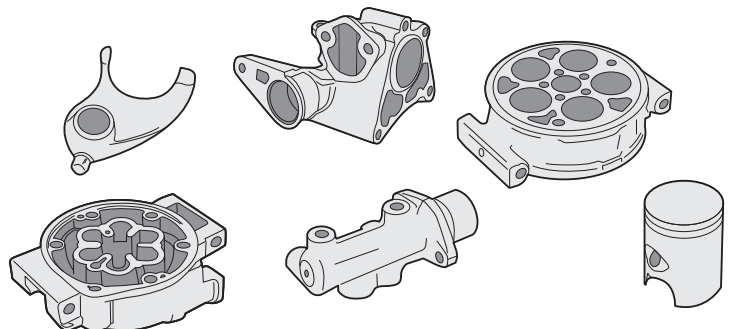

Components of Automotive Parts

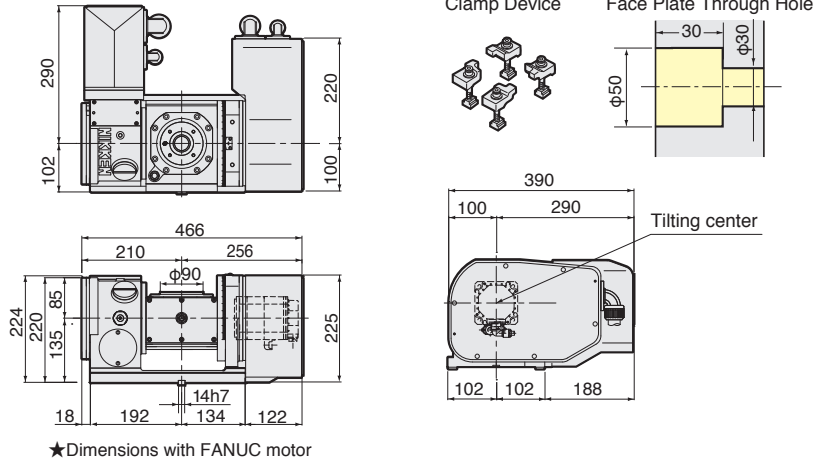

★Dimensions with FANUC motor



Specifications

Item / Code No.		5AX-100	
Diameter of Table	φmm	90	
Diameter of Spindle Hole	φmm	φ50H7 φ30	
Center Height (90°)	mm	135	
Table Height in Horizontal Position (0°)	mm	190	
Width of T Slot	mm	φ8H7 Pin hole	
Axis		Rotary	Tilting (0°~105°)
Clamping System		Pneumatic*1	Air Hydraulic Booster Built-in type
Clamping Torque	N·m	205	600
Table Inertia at Motor Shaft	$\frac{GD^2}{4}$ kg·m ² ×10 ⁻³	0.09	0.12
Servo Motor	r/min	α iF1·2000	α iF1·2000
MIN. Increment		0.001°	0.001°
Rotation Speed	r/min	44.4	22.2
Total Reduction Ratio		1/45	1/90
Indexing Accuracy	sec	±30	60
Net Weight	kg	84	
MAX. Work Load on the Table	0° to 30°	40 kg	
	30° to 90°	20 kg	
MAX. Thrust Load applicable on the Table	Tilting Angle = 0°	5300 N	
	Tilting Angle = 0°	L = 45mm F = 3820N	
	Tilting Angle = 90°	L ₁ = 0mm F ₁ = 2945N L ₂ = 100mm F ₂ = 1045N	
	Tilting Angle = 90°	FXL N·m 98	
MAX. Work Inertia		$\frac{GD^2}{4}$ kg·m ² 0.03	
Driving Torque		N·m 18	

The Area of Noninterference in Tilting Position.

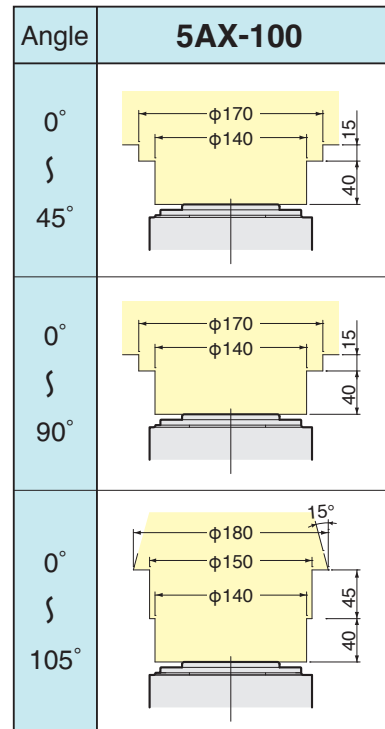

*1 Air Intensifying Booster system is available if the supplied air pressure is under 0.5MPa or the brake torque is required to increase. P.91

COMPACT TILTING ROTARY TABLE

NIKKEN

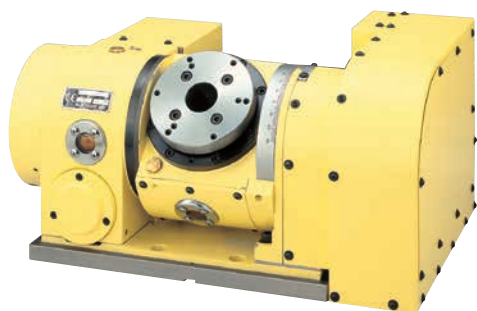

5AX-130FA

- Rotary and tilting axes are controlled by CNC
- Various kinds of attachments



Option				Accessories				
ADD. AXIS	ACCURACY SPEC.	ROTARY JOINT	ULTRA PRECISION	TAIL STOCK	SCROLL CHUCK	POWER CHUCK	CLAMP DEVICE	T-NUT
P.57	P.95	P.81	P.79	P.73	P.75	P.76	P.77	P.78

Specifications

Item / Code No.		5AX-130		5AX-201	
Diameter of Table	φmm	105		200	
Diameter of Spindle Hole	φmm	φ60H7 φ30		φ60H7 φ50	
Center Height (90°)	mm	150		180	
Table Height in Horizontal Position (0°)	mm	220		260	
Width of T Slot	mm	φ10H7 Pin hole		12 ^{+0.018} ₀	
Axis		Rotary	Tilting (0°~105°)	Rotary	Tilting (0°~105°)
Clamping System		Pneumatic*2	Pneumatic*2	Pneumatic*1*2/ Hydraulic	Pneumatic*1*2/ Hydraulic
Clamping Torque	N·m	205	303	303*1*2/ 588	303*1*2/ 612
Table Inertia at Motor Shaft	(GD ² / ₄) kg·m ² ×10 ⁻³	0.09	0.12	0.11	0.16
Servo Motor	r/min	α iF2·3000	α iF2·2000	α iF2·3000	α iS4·2000
MIN. Increment		0.001°	0.001°	0.001°	0.001°
Rotation Speed*3	r/min	33.3	11.1	33.3	16.6
Total Reduction Ratio		1/90	1/180	1/90	1/120
Indexing Accuracy	sec	±30	60	±15	60
Net Weight	kg	115		160	
MAX. Work Load on the Table	0° to 30°	50		60	
	30° to 90°	25		40	
MAX. Thrust Load applicable on the Table	Tilting Angle = 0°	5880		9800	
	Tilting Angle = 0°	L=65mm F=2940N		L=100mm F=4900N	
	Tilting Angle = 90°	L ₁ =0mm F ₁ =3460N L ₂ =100mm F ₂ =1590N		L ₁ =0mm F ₁ =5880N L ₂ =100mm F ₂ =2940N	
	Tilting Angle = 90°	98		382	
MAX. Work Inertia		0.12		0.5	
Driving Torque		72		72	

*1 Air brake system is also available for 5AX-201.

*2 Air Intensifying Booster system is available if the supplied air pressure is under 0.5MPa or the brake torque is required to increase. P.91

*3 The table rotation speed when the motor rotates at 3000r/min. Depending on the application(unbalance of the jig,work) and the motor specification, the motor may not be able to rotate at 3000r/min.

★Location of tilting axis motor can be changed as an option. e.g. 5AX-130B.

5AX-130, 5AX-201



External dimensions depend on the type of the servo motor. Indicated dimensions are in case of FANUC. Please contact us for CAD files (2D:DXF, 3D:PARASOLID).

5AX-130

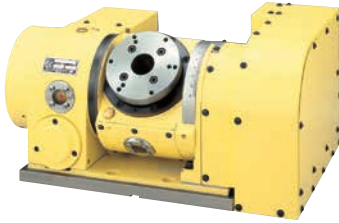
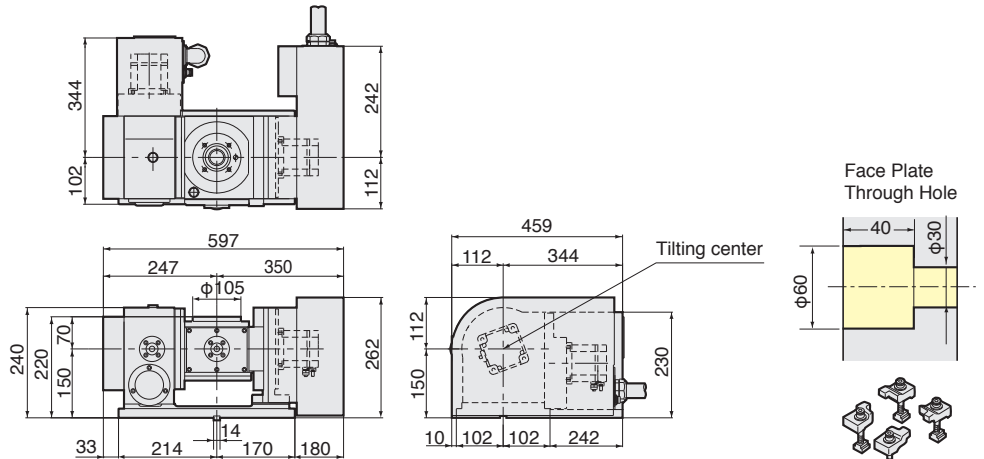

Photo with $\phi 130$ mm plate.
(Standard accessories)



Center height of high column table is 65mm higher than that of standard table.



Clamp Device

5AX-201

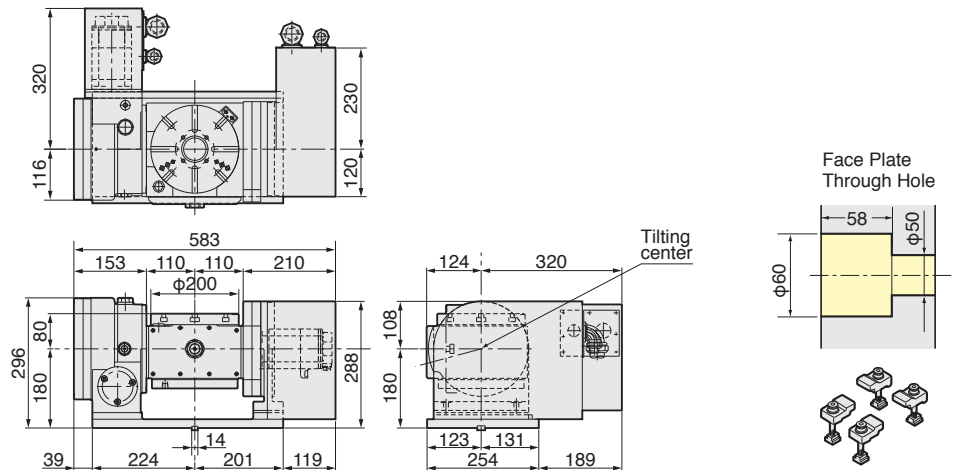
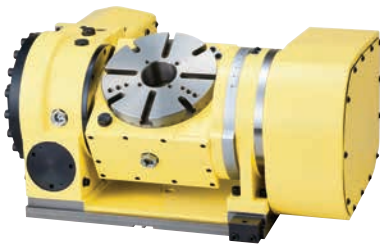

Built-in type 4 ports rotary joint can be attached on standard type as an option. (High column type is not necessary.)



Clamp Device

The Area of Noninterference in Tilting Position.

Angle	5AX-130	5AX-201
0°		
45°		
90°		
105°		

5AX-130BA

The tilting axis motor is mounted at back side.

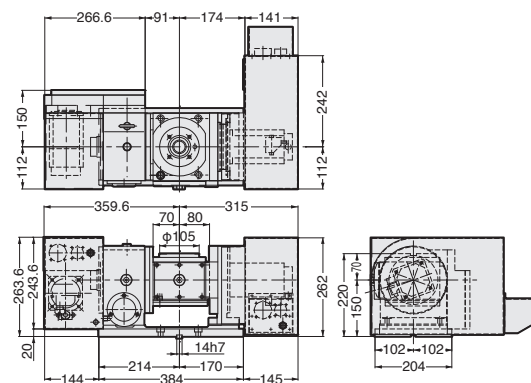

5AX-201BA

The tilting axis motor is mounted at back side.

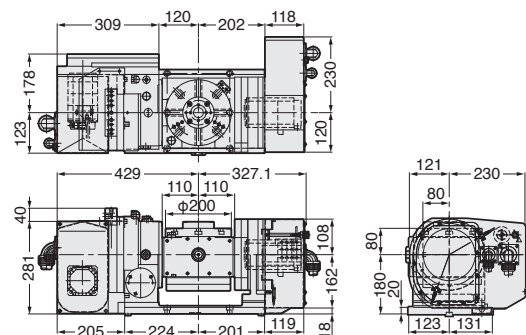

TILTING ROTARY TABLE

NIKKEN



5AX-230

- CNC tilting rotary table with powerful clamping system
- A best-selling product suitable for use with mediumsize machining center
- Ideal for lines consisting of horizontal machines only

Option				Accessories				
ADD. AXIS P.57	ACCURACY SPEC. P.95	ROTARY JOINT P.81	ULTRA PRECISION P.79	TAIL STOCK P.73	SCROLL CHUCK P.75	POWER CHUCK P.76	CLAMP DEVICE P.77	T-NUT P.78

Specifications

Item / Code No.		5AX-230*1		5AX-250	
Diameter of Table	φmm	230		250	
Diameter of Spindle Hole	φmm	φ60H7 φ40		φ60H7 φ50	
Center Height (90°)	mm	240		250	
Table Height in Horizontal Position (0°)	mm	285		250	
Width of T Slot	mm	12 ^{+0.018} ₀		12 ^{+0.018} ₀	
Axis		Rotary	Tilting (0°~105°)	Rotary	Tilting (0°~105°)
Clamping System		Hydraulic	Hydraulic	Hydraulic	Hydraulic
Clamping Torque	N·m	490	3430	588	490
Table Inertia at Motor Shaft	($\frac{GD^2}{4}$) kg·m ² ×10 ⁻³	0.3	0.5	0.11	0.16
Servo Motor	r/min	α iF4·2000	α iF8·2000	α iF4·2000	α iF4·2000
MIN. Increment		0.001°	0.001°	0.001°	0.001°
Rotation Speed	r/min	11.1	5.5	22.2	11.1
Total Reduction Ratio		1/180	1/360	1/90	1/180
Indexing Accuracy	sec	20	60	20	60
Net Weight	kg	220		290	
MAX. Work Load on the Table	0° to 30°	100		80	
	30° to 90°	100		50	
MAX. Thrust Load applicable on the Table	Tilting Angle = 0°	11760		9800	
	Tilting Angle = 0°	L=115mm	F=5880N	L=100mm	F=4900N
	Tilting Angle = 90°	L ₁ =0mm L ₂ =100mm	F ₁ =5880N F ₂ =2940N	L ₁ =0mm L ₂ =100mm	F ₁ =12040N F ₂ =6020N
	Tilting Angle = 90°	451		382	
MAX. Work Inertia	($\frac{GD^2}{4}$) kg·m ²	0.66		0.5	
Driving Torque	N·m	288		144	

*1 5AX-230 is semi-standard model.

5AX-230, 5AX-250



External dimensions depend on the type of the servo motor. Indicated dimensions are in case of FANUC. Please contact us for CAD files (2D:DXF, 3D:PARASOLID).

5AX-230



Center socket shown in photo is optional.

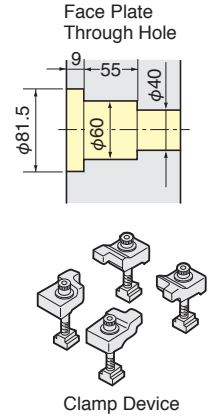
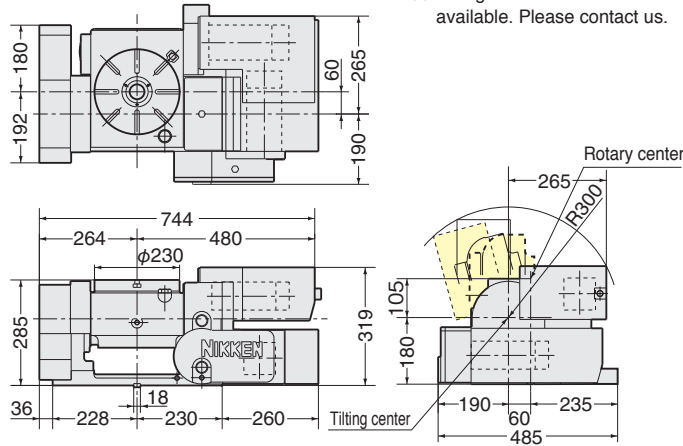

5AX-250

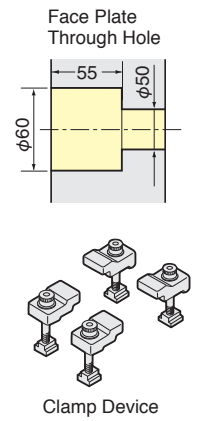
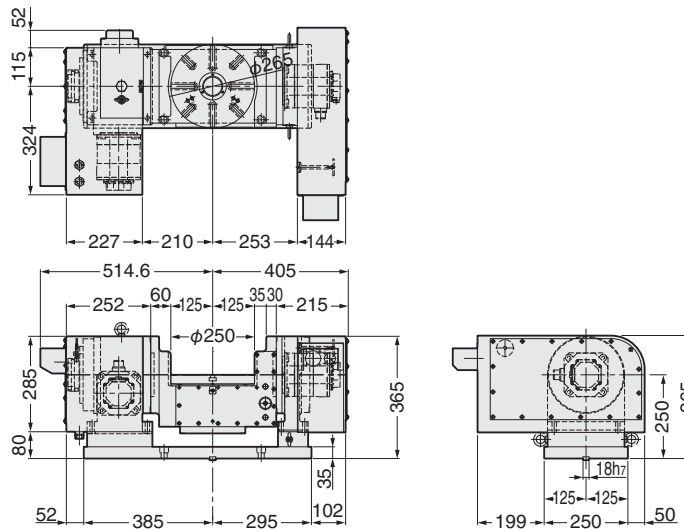

Built-in type 3 ports rotary joint can be attached on standard type as an option.

The Area of Noninterference in Tilting Position.

Example when tilting base is supplied from M/C builder.

Angle	5AX-230	5AX-250
0°		
45°		
90°		
105°		



Tilting Base

TILTING ROTARY TABLE

NIKKEN



5AX-350

- CNC tilting rotary table with powerful clamping system
- A best-selling product suitable for use with medium-size and large machining center
- Ideal for lines consisting of horizontal machines only

Option				Accessories				
ADD. AXIS P.57	ACCURACY SPEC. P.95	ROTARY JOINT P.81	ULTRA PRECISION P.79	TAIL STOCK P.73	SCROLL CHUCK P.75	POWER CHUCK P.76	CLAMP DEVICE P.77	T-NUT P.78

Specifications

Item / Code No.		5AX-350		5AX-550	
Diameter of Table	φmm	350		550	
Diameter of Spindle Hole	φmm	φ80H7		φ130H7	
Center Height (90°)	mm	300		380	
Table Height in Horizontal Position (0°)	mm	300		518	
Width of T Slot	mm	12 ^{+0.018} ₀		14 ^{+0.018} ₀	
Axis		Rotary	Tilting (0°~105°)	Rotary	Tilting (0°~105°)
Clamping System		Hydraulic	Hydraulic	Hydraulic	Hydraulic
Clamping Torque	N·m	1568	1568	3430	6272
Table Inertia at Motor Shaft	($\frac{GD^2}{4}$) kg·m ² ×10 ⁻³	0.8	1.35	5.5	5.2
Servo Motor	r/min	α iF8 ·2000	α iF12 ·2000	α iF12 ·2000	α iF12 ·2000
MIN. Increment		0.001°	0.001°	0.001°	0.001°
Rotation Speed	r/min	22.2	22.2	11.1	5.5
Total Reduction Ratio		1/90	1/90	1/180	1/360
Indexing Accuracy	sec	20	60	20	60
Net Weight	kg	420 (without Base:355)		1150	
MAX. Work Load on the Table	0° to 30°	200		500	
	30° to 90°	200		300	
MAX. Thrust Load applicable on the Table	Tilting Angle = 0°	19600		31360	
	Tilting Angle = 0°	L=175mm F=4900N		L=275mm F=9800N	
	Tilting Angle = 90°	L ₁ =0mm F ₁ =17160N L ₂ =100mm F ₂ =8580N		L ₁ =0mm F ₁ =19600N L ₂ =200mm F ₂ =14120N	
	Tilting Angle = 90°	858		2548	
MAX. Work Inertia	($\frac{GD^2}{4}$) kg·m ²	3.2		23	
Driving Torque	N·m	288		864	

LARGE TILTING ROTARY TABLE

NIKKEN











5AX-1200

- CNC tilting rotary table with powerful clamping system at both side
- Counter balance weight can be installed on 5AX-1200A to compensate the unbalancing load as standard
- Ideal for gantry type systems, machining centers, and 5-plane machines

Option				Accessories				
ADD. AXIS P.57	ACCURACY SPEC. P.95	ROTARY JOINT P.81	ULTRA PRECISION P.79	TAIL STOCK P.73	SCROLL CHUCK P.75	POWER CHUCK P.76	CLAMP DEVICE P.77	T-NUT P.78

Specifications

The specification will be varied according to your application. Please contact us.

Item / Code No.		5AX-800		5AX-1200	
Diameter of Table	φmm	800×500		1200	
Diameter of Spindle Hole	φmm	Φ130		Φ300H7	
Center Height (90°)	mm	550		750	
Table Height in Horizontal Position (0°)	mm	500		950	
Width of T Slot	mm	(14 ^{+0.018} ₀)*1		22 ^{+0.018} ₀ *1	
Axis		Rotary	Tilting	Rotary	Tilting (-20°~105°)
Clamping System	3.5MPa	Hydraulic	Hydraulic	Hydraulic	Hydraulic
Clamping Torque	N·m	4655	6125	14700	19600
Table Inertia at Motor Shaft $(\frac{GD^2}{4})$	kg·m ² ×10 ⁻³	6.8	6.0	10.8	3.5
Servo Motor	r/min	α iF22·2000	α iF40·2000	α iF22·2000	α iF22·2000
MIN. Increment		0.001°	0.001°	0.001°	0.001°
Rotation Speed	r/min	25	12.5	5.5	2.7
Total Reduction Ratio		1/60	1/120	1/360	1/720
Indexing Accuracy	sec	20	60	20	60
Indexing Accuracy of Ultra Precision *2	sec	±5	±10	±5	±10
Net Weight	kg	2300		7300	
MAX. Work Load on the Table	0° to 30°  kg	500		2500	
	30° to 90°  kg	500		1500	
MAX. Thrust Load applicable on the Table	Tilting Angle = 0°  N	31360		137200	
	Tilting Angle = 0°  N	2695		5488	
	Tilting Angle = 90°  N	2824		9600	
	Tilting Angle = 90°  N·m	2548		14700	
MAX. Work Inertia	 $(\frac{GD^2}{4})$ kg·m ²	23		276	
Driving Torque	 N·m	422		3168	

*1 Standard large rotary tables are without T slot. T slot is available as an option, please specify the width of the T slot.

SAX

5AX-800, 5AX-1200



External dimensions depend on the type of the servo motor. Indicated dimensions are in case of FANUC. Please contact us for CAD files (2D:DXF, 3D:PARASOLID).

5AX-800

Powerful double clamping system on both ends of tilting axis.

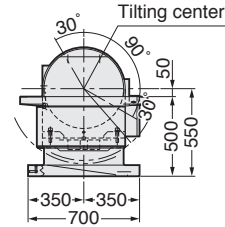
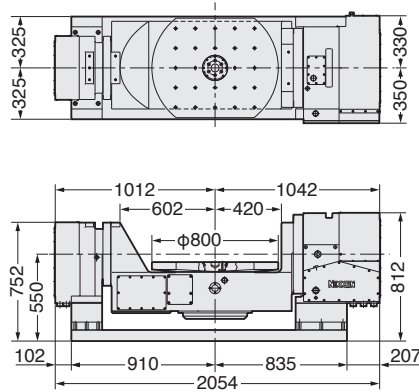

5AX-1200

Powerful double clamping system on both ends of tilting axis.



5AX-1200B

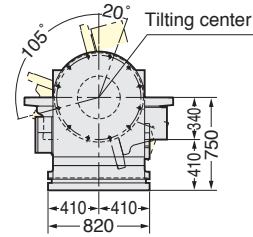
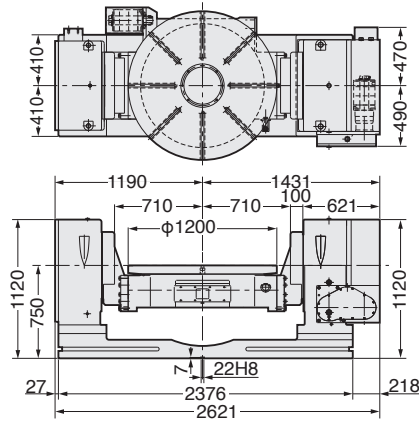

5AX-1200A is also available. The face plate is located above the center of the tilting axis.



The Area of Noninterference in Tilting Position.

Angle	5AX-800	5AX-1200
0° ∩ 45°		
0° ∩ 90°		
0° ∩ 120°		

Counter balance weight can be installed on 5AX-1200A to compensate the unbalancing load as standard.

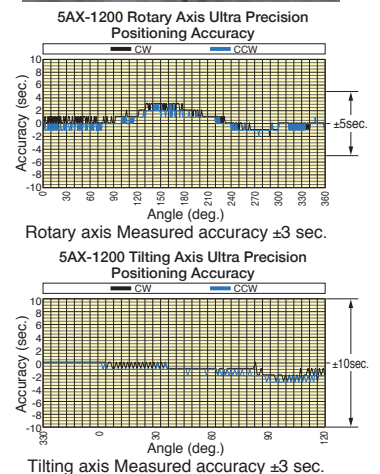
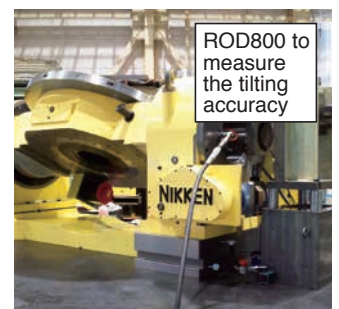
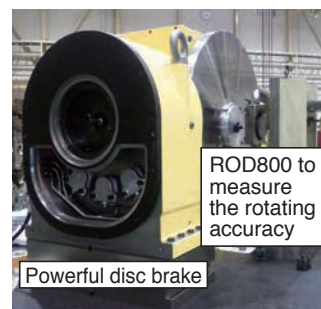

MULTI-SPINDLE TILTING ROTARY TABLE

NIKKEN







5AX-4MT-105-120

- Tilting rotary table with Multi-Spindle
- Various attachment for fixing work piece
- Ideal for small items and mass-produced parts

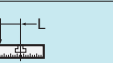
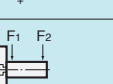
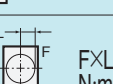

Option				Accessories				
ADD. AXIS	ACCURACY SPEC.	ROTARY JOINT	ULTRA PRECISION	TAIL STOCK	SCROLL CHUCK	POWER CHUCK	CLAMP DEVICE	T-NUT
P.57	P.95	P.81	P.79	P.73	P.75	P.76	P.77	P.78

Specifications Multi-Spindle Tilting Rotary Tables are all semi-standard models. Please contact us.

Item / Code No.		5AX-2MT-105-120		5AX-4MT-105-120	
Diameter of Table	φmm	105		105	
Diameter of Spindle Hole	φmm	φ60 _{H7} φ30		φ60 _{H7} φ30	
Number of spindles (Pitch)	mm	2 spindles (120)		4 spindles (120)	
Center Height (90°)	mm	175		235	
Table Height in Horizontal Position (0°)	mm	250		300	
Width of T Slot	mm	-		-	
Axis		Rotary	Tilting (0°~105°)	Rotary	Tilting (-110°~+110°)
Clamping System		Pneumatic*1	Pneumatic*1	Hydraulic	Hydraulic
Clamping Torque	N·m	147	147	147	343
Table Inertia at Motor Shaft $(\frac{GD^2}{4})$	kg·m ² ×10 ⁻³	0.13	0.13	0.2	0.48
Servo Motor	r/min	α iF2·3000	α iF2·2000	α iF8·3000	α iF4·2000
MIN. Increment		0.001°	0.001°	0.001°	0.001°
Rotation Speed*2	r/min	33.3	11.1	16.6	16.6
Total Reduction Ratio		1/90	1/180	1/180	1/120
Indexing Accuracy	sec	±30	60	±45	±30
Net Weight	kg	150		350	
MAX. Work Load on the Table	0° to 30° 	15 kg		25 kg	
	30° to 90° 	10 kg		15 kg	
MAX. Thrust Load applicable on the Table	Tilting Angle = 0° 	3920 N		3920 N	
	Tilting Angle = 0° 	L=60mm F1=784N		L=60mm F=2858N	
	Tilting Angle = 90° 	L1=0mm F1=653N L2=100mm F2=490N		L1=0mm F1=1380N L2=100mm F2=1040N	
	Tilting Angle = 90° 	49 N·m		49 N·m	
MAX. Work Inertia		0.014 $(\frac{GD^2}{4})$ kg·m ²		0.021 $(\frac{GD^2}{4})$ kg·m ²	
Driving Torque		36 N·m		144 N·m	

*1 Air Intensifying Booster system is available if the supplied air pressure is under 0.5MPa or the brake torque is required to increase.  P.91

*2 The table rotation speed when the motor rotates at 3000r/min. Depending on the application(unbalance of the jig,work) and the motor specification, the motor may not be able to rotate at 3000r/min.

★ Min. pitch between spindles:120mm. If you need different pitch, please contact us.

★ 4 spindle rotary table to suit 2 Spindle M/C is also available, please contact with us.

★ Max numbers of spindles:4 spindles.

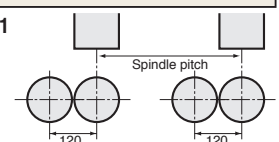

5AX-2MT, 5AX-4MT



External dimensions depend on the type of the servo motor. Indicated dimensions are in case of FANUC. Please contact us for CAD files (2D:DXF, 3D:PARASOLID).

5AX-2MT-105-120

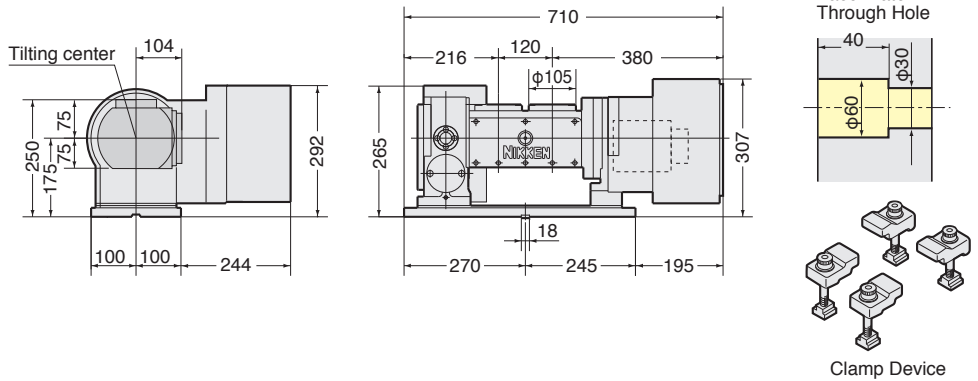

Center height of high column table is 35mm higher than that of standard table.
 MAX. number of ports in rotary joint Standard: 4 ports, High Column: 6 ports
 If you need a knock hole for positioning or a key way on the table surface, please contact us.

5AX-4MT-105-120

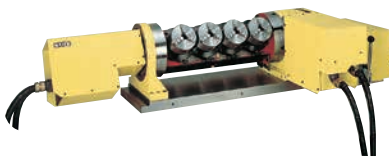

4" Power chuck in photo is optional.

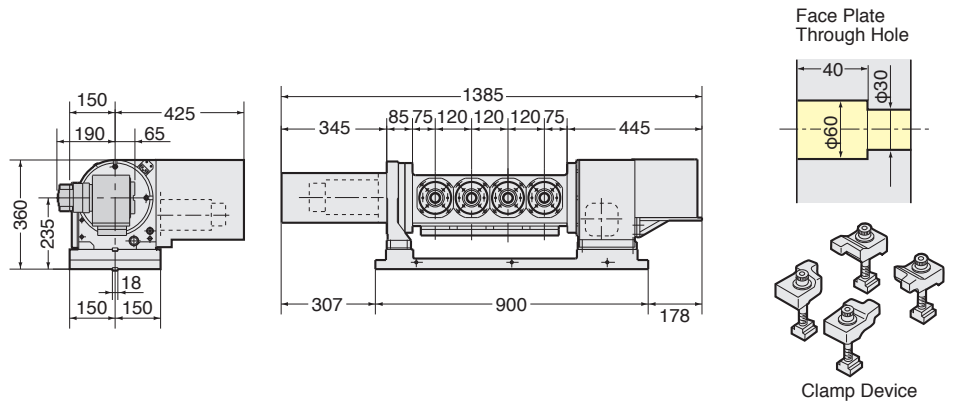

MAX. 6 port rotary joint can be installed on standard type as an option.
 If you need a knock hole for positioning or a key way on the table surface, please contact us.

Multi-Spindle Tilting Rotary Table

For Multi-Spindle Tilting Rotary Table, please contact us to know the required faceplate diameters, fixture attachment (e.g. Power Chuck etc), the required spindle pitch, the M/C model and the type of NC.



5AX

DD

CNC ROTARY TABLE WITH DD MOTOR

New

THE SMALLEST TILTING CNC ROTARY TABLE WITH DD MOTOR FOR COMPACT MACHINES



Ultra Compact Tilting Rotary Table with DD Motor

5AX-DD100

• Explanation of the Code No. (Example)

5AX-DD 201 A F 3

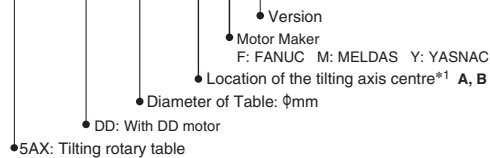

Option				Accessories			
ADD. AXIS	ACCURACY SPEC.	ROTARY JOINT	ULTRA PRECISION	TAIL STOCK	POWER CHUCK	CLAMP DEVICE	T-NUT
P.57	P.95	P.81	P.79	P.73	P.76	P.77	P.78

Only 554mm Wide

The Smallest 5AX with DD Motor

Demonstrates the true worth of a compact machining center with limited machining space.

With a body width of 554 mm, 5AX-DD100 is the smallest tilting rotary table with DD motor in NIKKEN's history. It is an ideal counterpart to products such as the BT30 compact machining center. It allows you to secure more machining space than was possible with earlier models.

Opens up New Possibilities for Machining with Compact M/C

Suitable for many applications, from IT parts to automotive parts.

High-precision 5-axis machining of precision electronic devices such as smartphones, automobile parts, etc. can be accomplished using a compact machining center.



Impeller

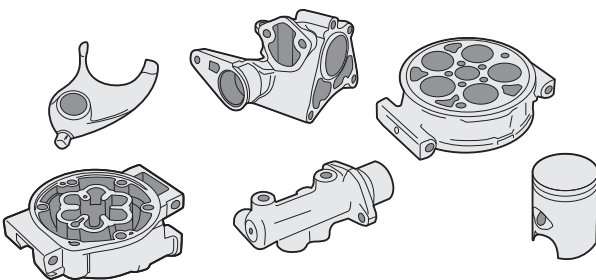

Components of Automotive Parts

High-acceleration/ deceleration.

Compact unit with high-speed rotation

Standout performers in 5-axis high-speed machining

This compact unit employs a DD motor for high-speed rotation and high-acceleration/deceleration. Opens up new possibilities for cutting and machining, ranging from IT parts requiring high-speed, high-grade machining to auto parts requiring high-speed machining.

NIKKEN's Exclusive "TT Solutions"

As an expert in both tables and tooling, NIKKEN offers more.

Allows for even higher precision and efficiency when combined with our Mini-Mini Chuck Advanced Alpha collets, which are standout performers in 5-axis machining.

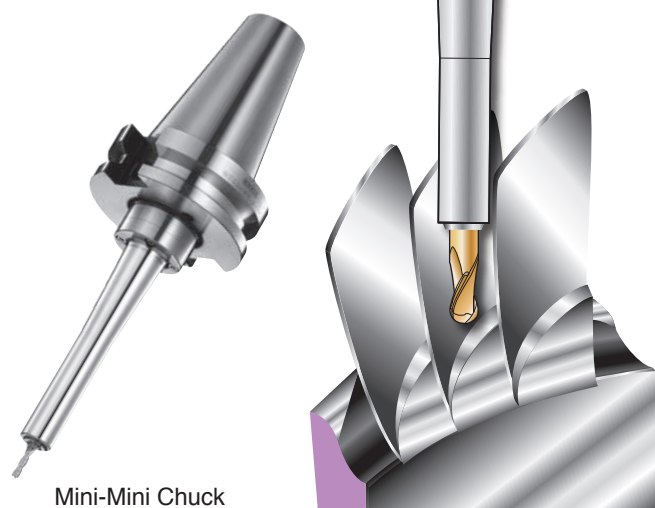

Mini-Mini Chuck Advanced Alpha

Image: 5AX Machining

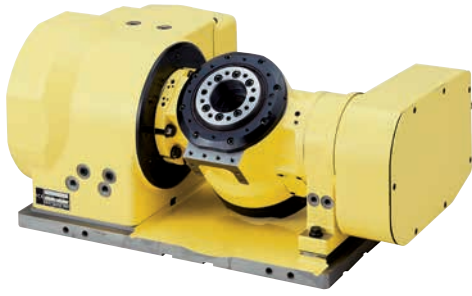

W/O
FACE
PLATE

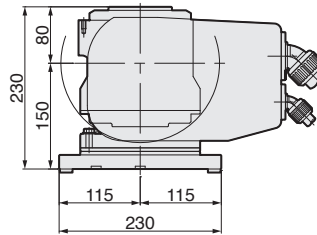
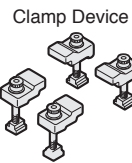
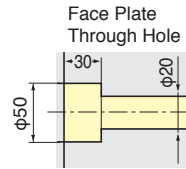
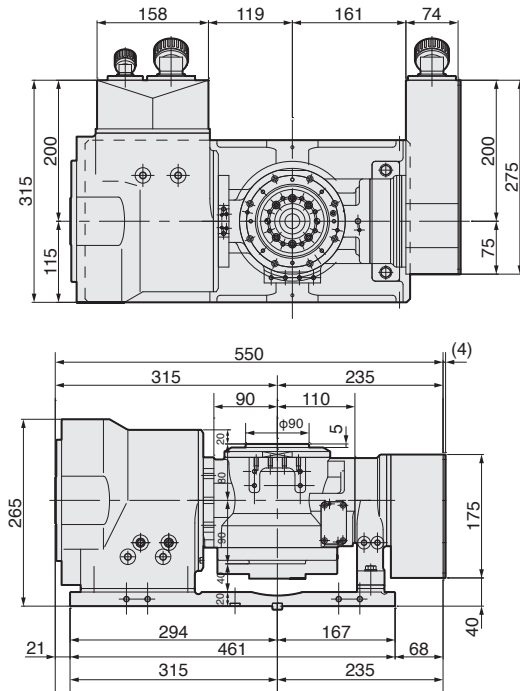

■ The Area of Noninterference in Tilting Position.

Angle	5AX-DD100
0° ∩ 45°	
0° ∩ 90°	
0° ∩ 110°	

DD

■ **Specifications** The external dimension and the specification will be varied according to the DD motor. Please contact us.

Item / Code No.	5AX-DD100AF	
Diameter of Table	φmm	90
Diameter of Spindle Hole	φmm	50H7 φ20
Center Height (90°)	mm	150
Table Height in Horizontal Position (0°)	mm	230
Width of T Slot	mm	φ8H7 Pin hole
Axis	Rotary	Tilting (0°~110°)
Clamping System	Pneumatic*1 (0.5MPa)	Pneumatic*1 (0.5MPa)
Clamping Torque	Nm	75 / 205
Motor (FANUC)	DiS15/1000	DiS60/400
Encoder	MPRZ-536A	MPRZ-536A
Min. Incremental	deg.	0.001
Rotation Speed	r/min	200 / 200
indexing Accuracy	sec.	±10 / ±1
MAX. Torque	Nm	35 / 130
Constant Torque	Nm	8.7/16*2 / 24/65*2
Net Weight	kg	120
MAX. Work Load	0~30deg. kg	20
	0~90deg. kg	10

*1 Air-air Booster system is available if the supplied air pressure is under 0.5MPa or the brake torque is required to increase. ☎ P.91

*2 Show the figures with cooling system.

CNC ROTARY TABLE with DD MOTOR

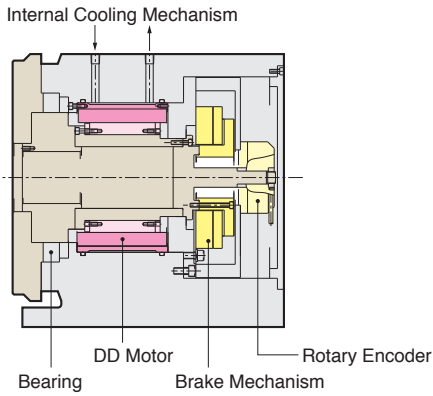

There is no mechanical reduction mechanism such as worm system in a rotary table with DD motor. DD (Direct Drive) motor is built in the the rotary table to drive directly. High rotation speed and high acceleration/deceleration can be done. However, the driving torque of the rotary table is not strong due to no mechanical reduction mechanism. Therefore, the suitable application of the rotary table with DD motor must be selected.

- High Response : 150r/min (DD251)
- High Response of Micro Spike Clamping System

Micro Spike

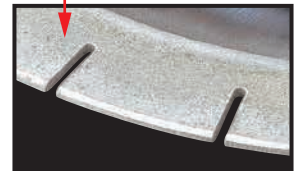

Configuration

● Explanation of the Code No.(Example)

DD 251 F - 150

- DD: rotary table with DD motor
- Diameter of Table 180, 250, 400
- Position of the Motor Cover No Letter: Right L: Left
- Motor Maker F: FANUC
- Code No. of the DD Motor

High-Acceleration / High-Speed / Compact Unit

- Suitable for the machining of the impeller.



Suitable for the machining of the impeller.

DD251F-150

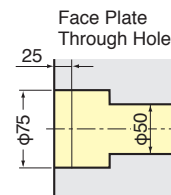
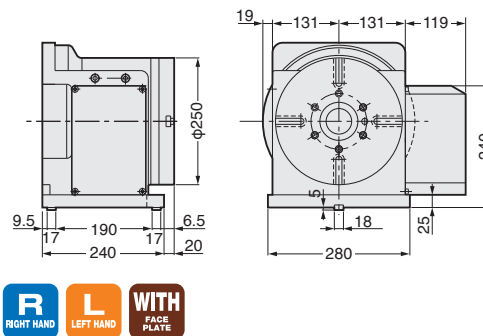

Clamp Device

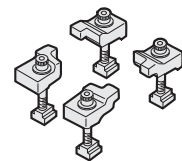

Specifications

The external dimension and the specification will be varied according to the DD motor. Please contact us.

Item / Code No.	DD201F-60	DD251F-150	DD402F-300	
Diameter of Table	φmm	200	250	400
Diameter of Spindle Hole	φmm	φ30H7	φ75H7	φ100H7
Center Height	mm	135	170	230
Width of T Slot	mm	12H7	12H7	14H7
Clamping System	Pneumatic*1 (0.5MPa)		Hydraulic(3.5MPa)	
Clamping Torqyue	Nm	150	500	930
Motor (FANUC)	DiS60/600-B	DiS180/800-B	DiS300/300-B	
Encoder	αiCZ Sensor 512A		αiCz Sensor 1024A	
Min. Incremental	deg.	0.001		
Rotation Speed	r/min	200	150	125
indexing Accuracy	sec.	±10		
Net Weight	kg	70	105	250
MAX. Work Load	kg	50	100	150
MAX. Torque	Nm	140	380	600
Constant Torque	Nm	34/65*2	73/170*2	100/215*2
Necessary Cooling Capacity	w	1500	1600	1500

*1 Air Intensifying Booster system is available if the supplied air pressure is under 0.5MPa or the brake torque is required to increase. P.91

*2 Show the figures with cooling system. Please be careful that cooling by the special liquid may not be good for the chiller system.

When cooling system is used, please check the cooling system, and stop the DD motor when the unusual condition is found.

ROTARY TILTING TABLE with DD MOTOR



5AX-DD201AF3 PAT.



WITH
FACE
PLATE

★The tilting axis center is located in the same position as the center of the rotary axis body.

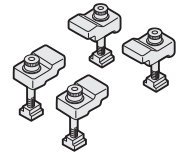
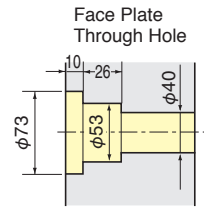
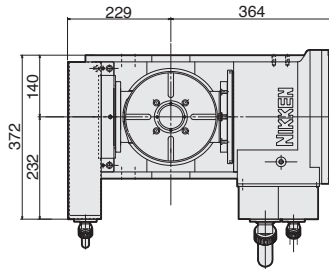
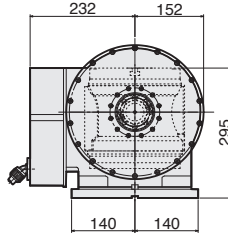

Clamp Device

5AX-DD201BF3 PAT.



WITH
FACE
PLATE

★The tilting axis center is located in the same position as the top surface of the rotary axis body.

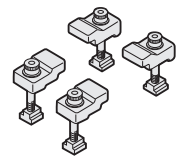
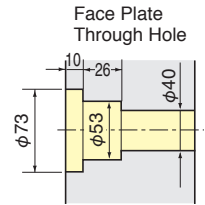
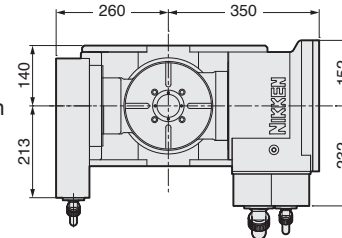
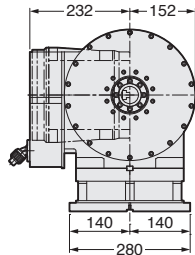

Clamp Device

DD

Specifications

The external dimension and the specification will be varied according to the DD motor. Please contact us.

The Area of Noninterference in Tilting Position.

Item / Code No.	5AX-DD201AF3		5AX-DD201BF3	
Diameter of Table φmm	200		200	
Diameter of Spindle Hole φmm	φ53H7		φ53H7	
Center Height (90°) mm	195		270	
Table Height in Horizontal Position (0°) mm	295		270	
Width of T Slot mm	12H7		12H7	
Axis	Rotary	Tilting (±110°)	Rotary	Tilting (±110°)
Clamping System	Pneumatic*1 (0.5MPa)	Pneumatic*1 (0.5MPa)	Pneumatic*1 (0.5MPa)	Pneumatic*1 (0.5MPa)
Clamping Torque Nm	150	500	150	500
Motor (FANUC)	DiS60/600-B	DiS180/800-B	DiS60/600-B	DiS180/800-B
Encoder	α iCZ 512A		α iCZ 512A	
Min. Incremental deg.	0.001		0.001	
Rotation Speed r/min	200	150	200	150
indexing Accuracy sec.	±10	±15	±10	±15
MAX. Torque Nm	140	400	140	400
Constant Torque Nm	34	75/180*2	34	75/180*2
Net Weight kg	185		205	
MAX. Work Load	0~30deg. kg	30	30	30
	0~90deg. kg	15	15	15

Angle	5AX-DD201AF3	5AX-DD201BF3
-45° ∪ 45°		
-90° ∪ 90°		
-110° ∪ 110°		

*1 Air Intensifying Booster system is available if the supplied air pressure is under 0.5MPa or the brake torque is required to increase. P.91

*2 Show the figures with cooling system. Please be careful that cooling by the special liquid may not be good for the chiller system.

When cooling system is used, please check the cooling system, and stop the DD motor when the unusual condition is found.

ROTARY TILTING TABLE with HIGH-SPEED DD MOTOR NEW NIKKEN

5AX-DD201BF3-HSR PAT.



WITH
FACE PLATE

*1、*2:
Spindle center cooling port.
Please use either one.

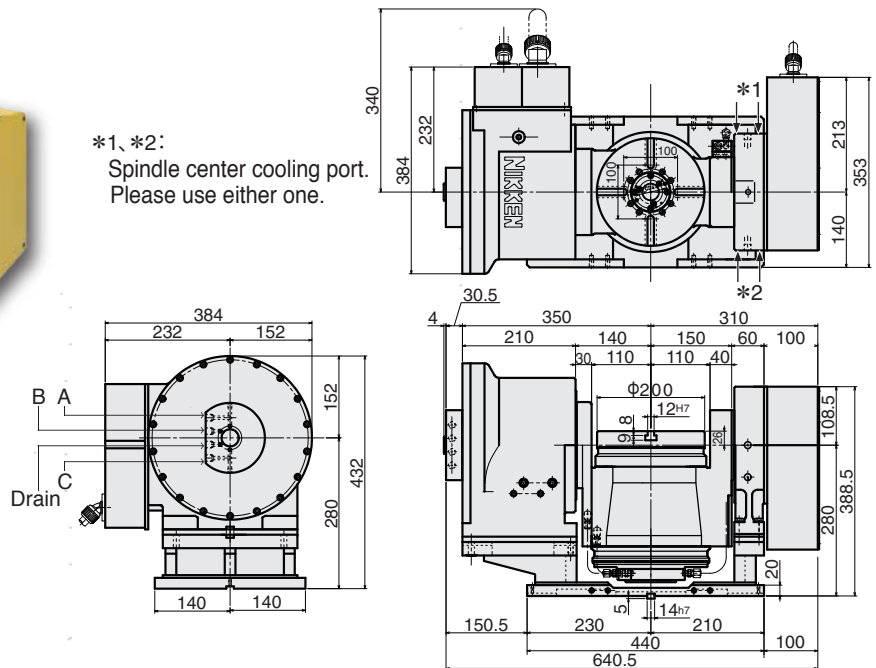

Combining 5AX-DD201BF3-HSR table with NIKKEN Turning KIT (option), FANUC ROBODRILL enables turning operation.

- High speed rotation of 1,500 r/min on the rotary axis enables turning operation.
- Spindle center cooling system is built, suppresses temperature rise during continuous turning operation. **PAT.**
- 3-port rotary joint and drain port are standard. **PAT.**
The A and B ports are for hydraulic use only, and oil will be collected from the drain port to returned to the hydraulic tank.
The C port is for pneumatic use only.

Item / Code No.	5AX-DD201BF3-HSR	
Diameter of Table	Φmm	200
Center Height (90deg)	mm	280
Table Height in Horizontal Position (0deg)	mm	306
Width of T Slot	mm	12H7
Axis	Rotary	Tilting (0~110°)
Clamping System	Pneumatic	Pneumatic
Clamping Torque	Nm	150
Motor (FANUC)	DiS60/1500-B	Dis180/800-B
Amplifier capacity	A	80
Encoder	aiCZ 512A	
Min. Incremental	0.001	
Rotation Speed	r/min	1500
Indexing Accuracy	sec.	±10
Net Weight	kg	240
Max. Work Load	0~30deg. kg	30*1
Max. Torque	0~90deg. Nm	140
Constant torque	Nm	60*2
Required cooling capacity	W	1800



★ NIKKEN Turning KIT is a set of optional accessories that includes an anti-rotation block and its control system.

*1 Max. work Load: 7.5kg Max. work inertia: $9.3 \times 10^{-3} \text{ kg} \cdot \text{m}^2$.

*2 The motor for the rotary axis needs cooling. Please prepare a cooling device (chiller) for operation. Cooling oil may be restricted by the cooling device, so select it appropriately. Cooling should be implemented with a system that continuously monitors the cooling system status and stops the system in case of abnormalities.

*3 This value applies when the table body is cooled with coolant.

DD table characteristics

- The spindle is linked directly to the motor for excellent responsiveness. As a tradeoff for this responsiveness, the system is very sensitive to external force and loads, so it is necessary to set suitable parameters for each application.
- Adjustment is necessary to perform 5-axis simultaneous machining (synchronized machining). The NIKKEN standard parameters can be used for indexing and positioning. After confirming with the machine manufacturer that optional functions* for synchronized machining are available, it is necessary to make appropriate settings to satisfy the customer's machining time and machining precision requirements. For simultaneous operation, suitable settings must be made to align the 4th (5th) axis with the three basic axes (XYZ).

Clamping operation

Due to the characteristics of the DD table it can be turned easily by hand if power is not being supplied (free run state). The table will again be in the free run state when the servo turns off after the brake is applied, unless appropriate settings are made, and this can cause positioning inaccuracy. Consult with the machine manufacturer to ensure that the timing is as shown in the timing chart below to prevent a free run state from occurring.

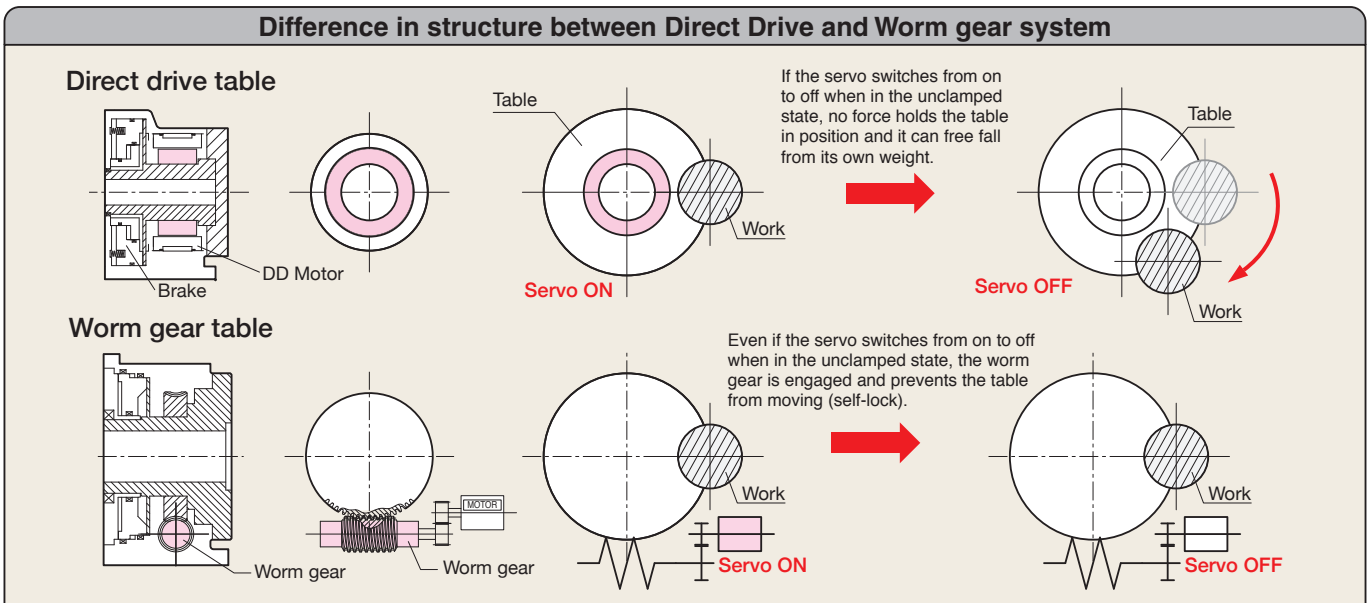

- **Preventing emergencies (in case of power interruption)**
Configure a pneumatic (hydraulic) circuit (off-clamp) that will provide an emergency stop occur. Unlike normal clamping operation, in an emergency stop the brake is applied at the same time that the servo turns off momentarily, and this can result in positioning inaccuracy on an axis carrying a large load, such as the weight axis. To prevent this, enable the brake control function (FANUC), vertical axis drop prevention function (Mitsubishi), etc.

- **Brake control function**
To prevent the fall of the weight axis when an alarm is generated or an emergency stop occurs, instead of stopping excitation of the motor immediately, excitation of the motor continues for the duration specified by a parameter to allow the mechanical brake to engage.

- **Shaft core cooling system PAT.**
In the case of a DD table for turning, there is also a system that forcibly cools from the center of the table in order to suppress the thermal displacement of the DD table itself.

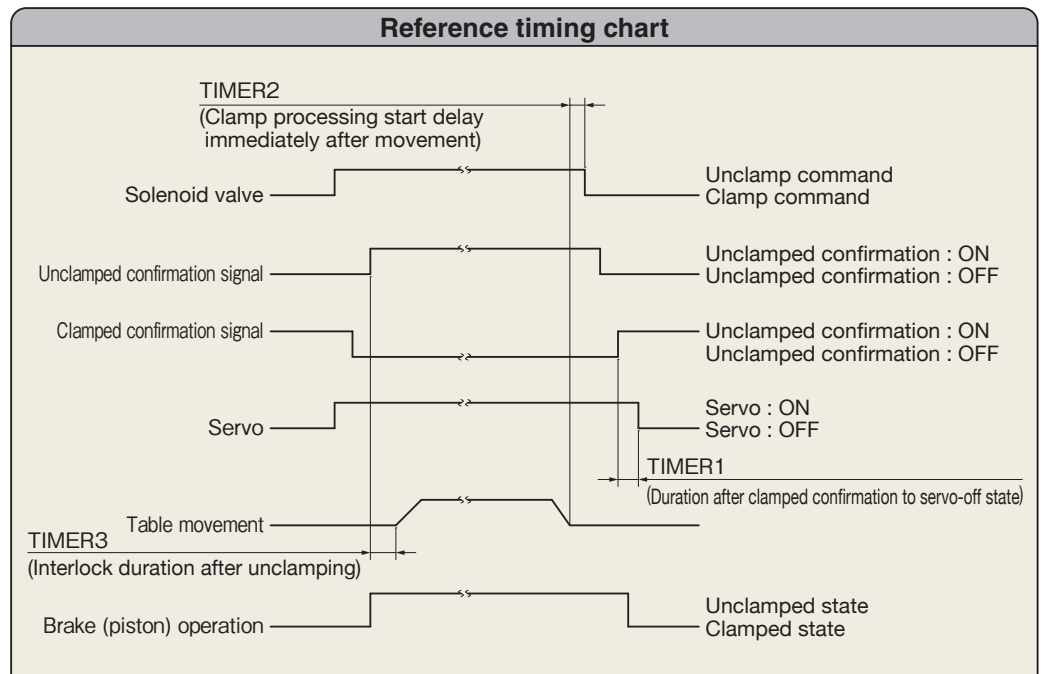

⚠ Cooling of Direct Drive Servomotor

Except for some types of direct drive servomotor, you can choose no-cooling or liquid cooling. Keep cooling makes it possible to use under continuous rating torque. However, the special care is required because the continuous rating torque may fluctuate depending on the cooling condition.

External cooling devices should be prepared for cooling, such as chiller unit which is normally used for high speed spindles. Oil cooling must be used; water cooling is not allowed to prevent the rust. Recommended cooling oil is [ISO VG2] equivalents. (Ex. IDEMITSU "SUPER MULTI 2")

- In the case cooling is needed : ① Long time continuous running under high (close to maximum) speed rotation ② Very long time running under overload (above rated torque-below maximum torque) ③ Using special super-high speed servomotors
- Examples of cooling needed : ① Always-servo on under high-load condition (continuous turning operation) ② No-brake or the configuration that the servo is not off when clamping (Note: NIKKEN default configuration is servo OFF when clamping)
- Examples of cooling NOT needed : ① Indexing only ② Special use considering overload duty characteristics during non-cooling

Please feel free to contact us if you need any concerns of questions regarding cooling or if you use direct drive rotary table under special conditions.

BUILT-IN BUILT-IN type CNC ROTARY TABLE

External dimensions depend on the type of the servo motor. Indicated dimensions are in case of FANUC. Please contact us for CAD files (2D:DXF, 3D:PARASOLID).

CNC400H

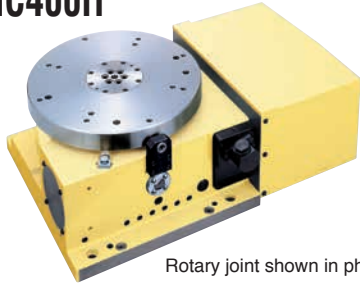

Rotary joint shown in photo & layout is optional.

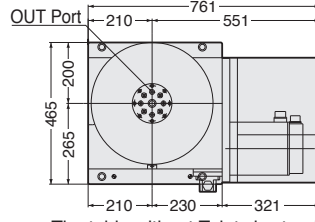
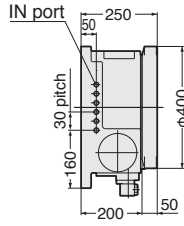

The table without Tslots is standard.

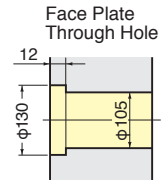

★Horizontal use only.

CNC503H

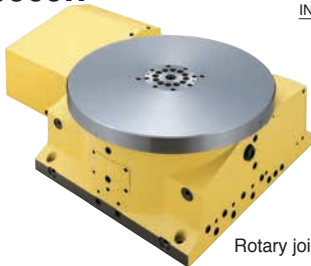

Rotary joint shown in photo & layout is optional.

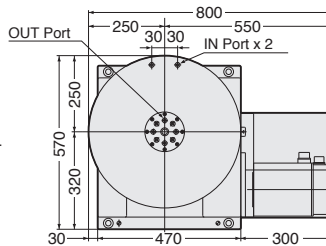
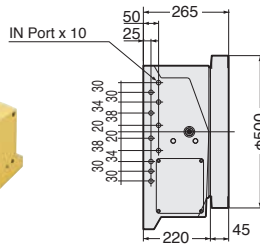

The table without Tslots is standard.

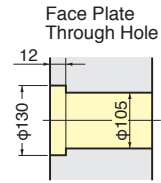

★Horizontal use only.

- 12 Ports Rotary Joint is optional.
- Suitable design for easy maintenance
- Economical price due to standardization

B-type and T-Type are now available. Please contact us for more detail.

CNC802

Ultra Big Bore (φ270mm) Specification

★ Built-in type rotary joint can be mounted on CNC802 refer to [P.82](#)

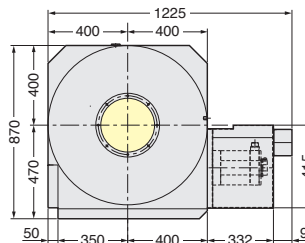
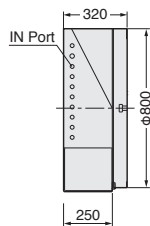
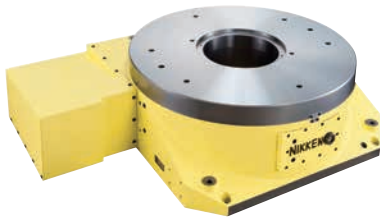



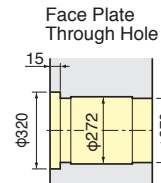

The table without Tslots is standard.



Specifications

Built-type CNC Rotary Tables are all semi-standard models. Please contact us.

() : High Speed type Please contact us.

Item / Code No.		CNC400H CNCZ400H	CNC503H CNCZ503H	CNC802	
Diameter of Table	φmm	φ400	φ500	φ800	
Diameter of Spindle Hole	φmm	φ105 _{H7}	φ105 _{H7}	φ270 _{H7}	
Clamping System	3.5MPa	Hydraulic	Hydraulic	Hydraulic	
Clamping Torque	N·m	1760	1890	7000	
Table Inertia at Motor Shaft ($\frac{GD^2}{4}$)	kg·m ² ×10 ⁻³	2.8	8	5.3	
Servo Motor	r/min	α iF12·2000	α iF12·2000	α iF22·2000	
MIN. Increment		0.001°	0.001°	0.001°	
Rotation Speed	r/min	22.2(44.4)	16.6(33.3)	5.5	
Total Reduction Ratio		1/90 (1/45)	1/120 (1/60)	1/360	
Indexing Accuracy	sec	20	20	15	
Net Weight	kg	295	400	1100	
MAX. Work Load on the Table	Horizontal				
		kg	500	1000	3000
	Thrust Load applicable on the Table	N	53100	63720	247920
MAX. Thrust Load applicable on the Table	*1 	N	2648	3531	8563
		FXL N·m	3840	5990	36260
MAX. Work Inertia	 ($\frac{GD^2}{4}$) kg·m ²	16.6(8.3)	32.5(16.3)	234	
Driving Torque	 N·m	432(345)	576(460)	3168	

*1 This is the strength of the worm wheel without brake. It is applied against dynamic cutting thrust.

BUILT-IN type TILTING ROTARY TABLE

NIKKEN

External dimensions depend on the type of the servo motor. Indicated dimensions are in case of FANUC. Please contact us for CAD files (2D:DXF, 3D:PARASOLID).

5AX-T400, N400

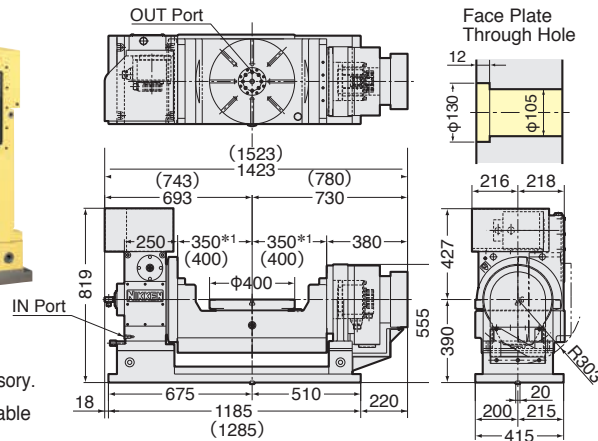

Built-in type 8 ports rotary joint is optional accessory.
The position of the motor of the tilting axis table can be right & left side for the vertical M/C.

* () : Figures is for **N400**.
*1500 is available on the figures marked.

5AX-B450

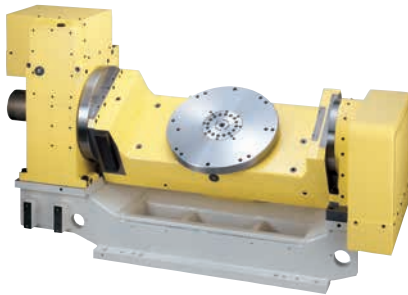

Tilting base will be supplied from M/C builder.

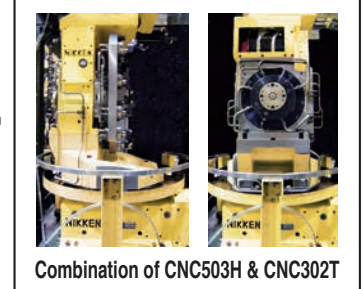
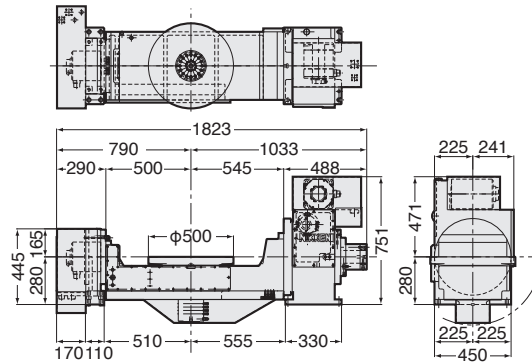

Built-in type 17 ports rotary joint is optional accessory.
The position of the motor of the tilting axis table can be right or left side for the vertical M/C.



Item / Code No.	5AX-T400 N400		5AX-B450	
	Rotary	Tilting	Rotary	Tilting
Diameter of Table ϕ mm	400		500	
Diameter of Spindle Hole ϕ mm	$\phi 105_{H7}$		$\phi 155_{H7}$ $\phi 109$	
Center Height (90°) mm	390		280*1	
Table Height in Horizontal Position (0°) mm	390		280*1	
Width of T Slot mm	14 ^{+0.018} ₀		—	
Axis	Rotary	Tilting	Rotary	Tilting
Clamping System 3.5MPa	Hydraulic	Hydraulic	Hydraulic	Hydraulic
Clamping Torque N·m	1760	1760	1760	3870
Table Inertia at Motor Shaft ($\frac{GD^2}{4}$) kg·m ² ×10 ⁻³	2.8	2.44	2.8	2.9
Servo Motor r/min	aiF12 ·2000	aiF22 ·2000	aiF12 ·2000	aiF22 ·2000
MIN. Increment	0.001°	0.001°	0.001°	0.001°
Rotation Speed r/min	22.2	16.6	22.2	16.6
Total Reduction Ratio	1/90	1/120	1/90	1/120
Indexing Accuracy sec	15	60	20	60
Net Weight kg	750(w/o base) 995(with base)		1050(w/o base)	

Item / Code No.	Diagram	5AX-T400 N400	5AX-B450
		MAX. Work Load on the Table	300
	30° to 90°	250	250
	Tilting Angle = 0°	31360	31360
MAX. Thrust Load applicable on the Table	Tilting Angle = 0°	L=200mm F=6860N	L=250mm F=5488N
	Tilting Angle = 90°	L=100mm F=11660N	L=100mm F=11660N
	Tilting Angle = 90°	1166	1166
MAX. Work Inertia		5.1	5.1
Driving Torque		432	432

★ Ultra precision type is available for all rotary tables, Rotary axis: $\pm 5''$ Tilting axis: $\pm 10''$, please refer to P.79.
The figures marked *1 show the dimension without tilting axis base.

BUILT-IN

Servo Motor List



Maker and Motor Model

Stall Torque	1 Nm		2 Nm		3 Nm		6 Nm		12 Nm		22 Nm		
Rotation Speed	2000r/min		2000r/min		2000r/min		2000r/min		2000r/min		2000r/min		
Maker	Model 1		Model 2		Model 3		Model 6		Model 12		Model 22		
FANUC	αiF1/5000		αiF2/5000		αiF4/5000		αiF8/3000		αiF12/4000		αiF22/3000		
	αiS2/5000		αiS4/5000		αiS8/4000		αiS12/4000		αiS22/4000		αiS30/4000		
	βiS2/4000		βiS4/4000		βiS8/3000		βiS12/3000		βiS22/2000				
MELDAS	HF75T		HF105T		HF54T		HF104T		HF204S		HF354S		
					HP54T		HP104T		HP204S		HP354S		
	HG56T		HG75T		HG104T		HG154T		HG204S		HG354S		
YASNA	SGMPH-04AAA6S		SGMPH-08AAA6S		SGMGH-05ACA5S		SGMGH-09ACA5S		SGMGH-20ACA2S		SGMGH-30ACA2S		
	SGMAV-04A3A6S		SGMGV-03A3A6S		SGMGV-05A3A6S		SGMGV-09A3A6S		SGMGV-20A3A2S		SGMGV-30A3A2S		
	SGM7A-04A7A6S		SGM7G-03A7A6S		SGM7G-05A7A6S		SGM7G-09A7A2S		SGM7G-20A7A2S		SGM7A-30A7A2S		
OSP	OSP2			BL-MC24J-30S		BL-MC25J-30T		BL-MC50J-30T		BL-MC100J-20S		BL-MC200J-20S	
	OSP3			BL-ME24J-50SN		BL-ME40J-40TN		BL-ME80J-40TN		BL-ME100J-30SN		BL-ME200J-20SN	
	OSP4 OLD			BL-ME24M-50SN		BL-ME40M-40TN		BL-ME80M-40TN		BL-ME100M-30SN		BL-ME200M-20SN	
	OSP4 NEW					BL-MT40M-40TN		BL-MT80M-40TN		BL-MT100M-30SN		BL-MT200M-20SN	
	OSP5					BL-MT40M-40TN		BL-MT80M-40TN		BL-MT100M-30SN		BL-MT200M-20SN	
TOSNUC					MFA055MBJNC1		MFA100MBJNC1		MFA180MBJNB		MFA350MBJNB		
	MDM032R4L		MDM062R4L		MDM052R4L		MDM152R4L		MDM212R4C		MDM402R4C		
	MHMD482S1C		MHMD082S1C		MHMA052K2LA		MHME102F2CA		MTMA402F2CA		MTMA552F2CA		
Brother	SANYO*1	R2AD08040FXPGA				R2AAB8100HXPGA							
	SANYO*2	R2AA08040FXR5E				R2AAB8100HXRGA							
SIEMENS	1FT-6031-4AK71		1FT-6034-4AK71		1FT-6044-1AK71		1FT-6064-1AK71		1FT-6082-1AF71		1FT-6086-1AF71		
			1FK-7042		1FK-7060		1FK-7063		1FK-7083				
HEIDENHAIN			QSY96A		QSY116C		QSY116E		QSY155B		QSY155D		

*1 The end of the rotary table Code No. is "SA-BR2".

*2 The end of the rotary table Code No. is "SA-BR3".

★The characteristics (stall torque, MAX. torque and rotor inertia etc.) of the servo motors differ, therefore the specification of CNC rotary table will be a little different.

★Other servo motor can be mounted, please inform us the external dimension, specification of your servo motor.

Relation between Unbalancing Load and Servo Motor



This table shows the guide line. Please make the unbalancing load as small as possible to use the counter balance weight for the precision machining.

Excessive unbalancing load causes the indexing accuracy and the durability to be worse. The relation between the guide line of the unbalancing load and the servo motor shows below. Please do not apply the load exceeding the guide line.

CNCZ series table can not be recommended for the application with large unbalancing load. CNCZ series table is recommended for the application only with light load.

Please inform us the detail of the component, jig fixture, indexing time etc. prior to your order. Then, the calculation of the load is studied and the best suitable rotary table (including the suitable motor) for your application is proposed. The servo parameter is also tuned.

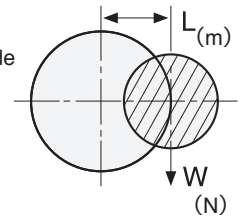

Guide Line of MAX. Unbalancing Load for Additional Axis Control

FANUC motor is described.

Please contact us for the other maker.

MAX. Unbalancing Load (N·m)	CNC180FA	CNC202FA	NCT200(E)FA	CNC ^{260FA} _{302FA}	CNC ^{321FA} _{401FA}	CNCB450FA	CNC ^{501FA} _{601FA}
30	αiF2						
50	αiF4	αiF4					
60			αiF4	αiF4			
100				αiF8	αiF12		
150						αiF12	
200						αiF22	αiF12
300						αiF22	
400							αiF22

Guide Line of MAX. Unbalancing Load with NIKKEN Controller

MAX. Unbalancing Load (N·m)	CNC180	CNC202	NCT200	CNC260(P)	CNC302(P)
10	CNC180AR21-04				
20	CNC180AR21-08	CNC202AR21-08	NCT200AR21-08		
30				CNC260AR21-08	CNC302AR21-08
50	CNC180AR21-06	CNC202AR21-06			
60			NCT200AR21-06	CNC260AR21-06	CNC302AR21-06

Flow Chart of the Additional Axis Control

Servo enable is basically kept OFF during the mechanical brake clamps. Servo enable is recommended to be kept ON, even when the mechanical brake clamps for the CNC rotary tables listed in the box below. But, the case when a big electric current always flows in the motor due to the heavy unbalancing load, please keep servo enable OFF when the mechanical brake clamps.

- CNC321, 401, 501, 601, 802, 803
- CNC400H, 503H
- 5AX-250 (Tilting)
- 5AX-T(N)400 (Rotary. Tilting)

Please specify the brake control when ordering

- Type of solenoid valve (AC100V or DC24V)
- Motion of solenoid valve for clamp (ON: Clamp, OFF: Clamp)

Flow Chart of the Additional Axis Control

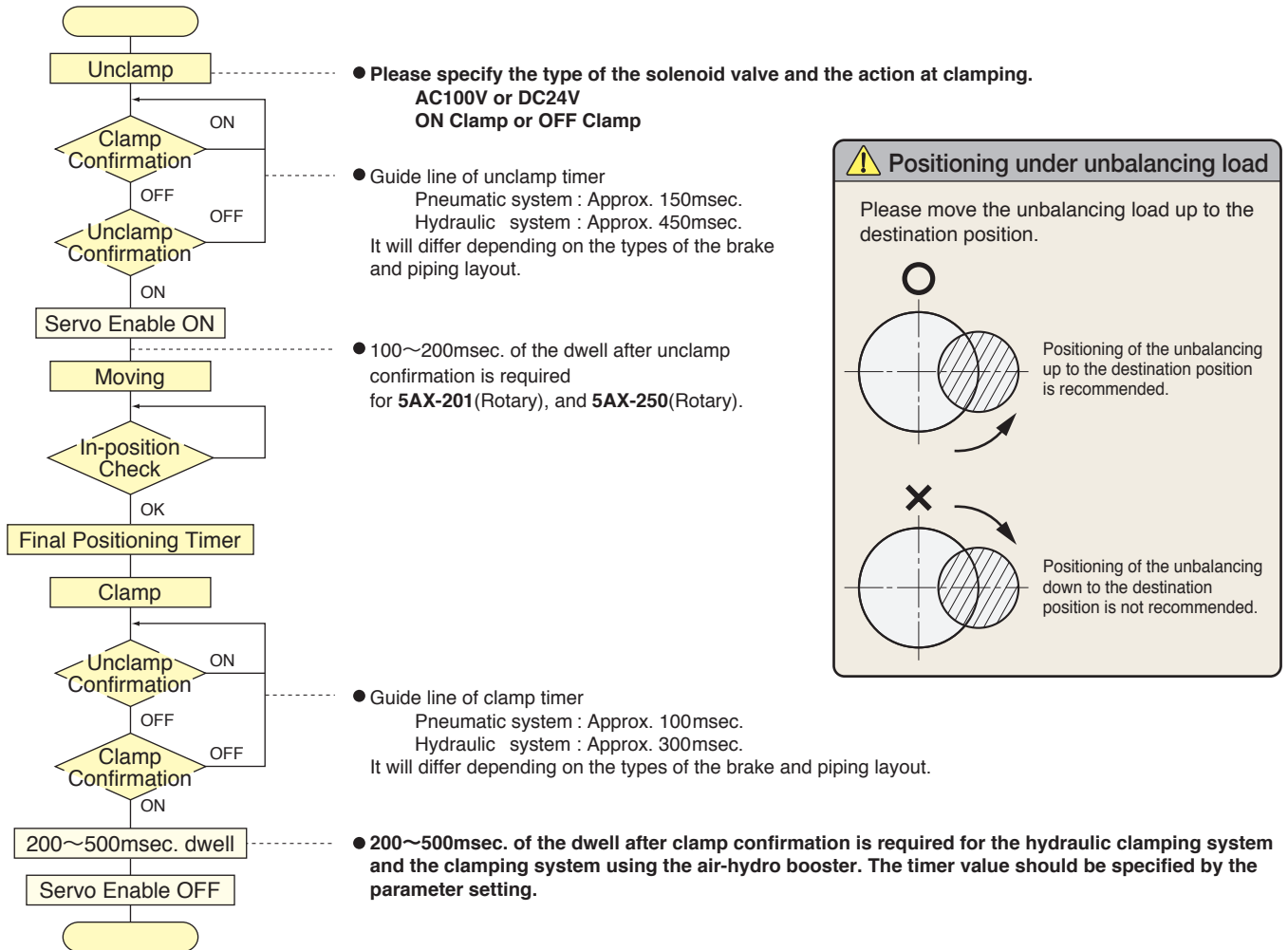

Indexing Time

Guide line of the indexing time is shown. The indexing time will be different according to the total reduction ratio, motor rotation speed, servo parameter setting and the piping of the brake circuit. Please contact us for more detail.

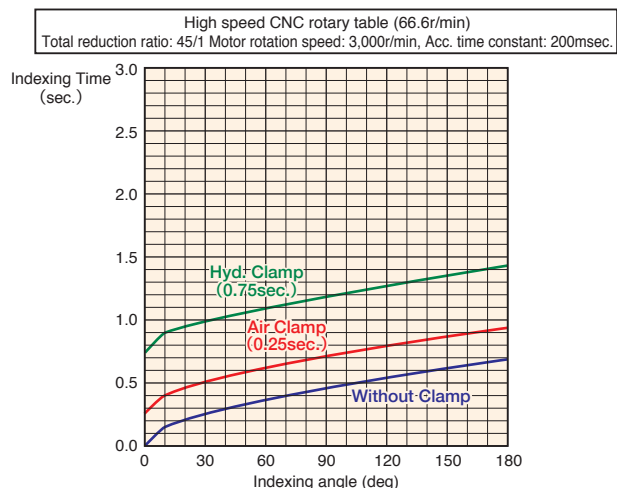
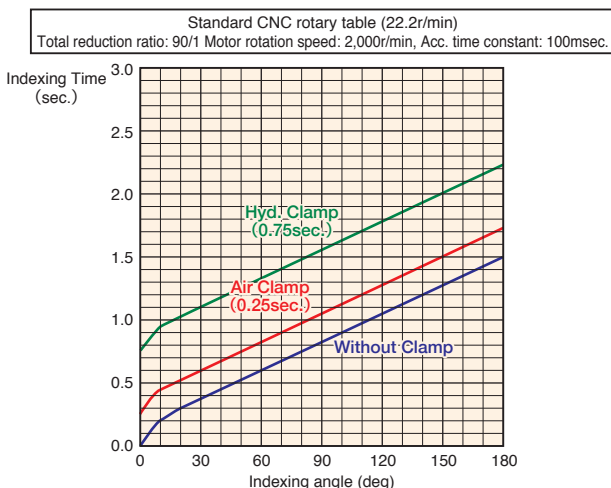

M-signal CNC ROTARY TABLE with AR21 CONTROLLER

Minimum Command Increment: 0.001° or 1sec.

AR21 controller can drive all models of NIKKEN CNC rotary table.

Single M signal provides Various Automatic Operation.

Any unequal dividing, equal dividing, arc cutting, lead cutting etc. can be done very easily.

USB interface as standard equipment

By connecting to a PC, program data and parameters can be input and output. (However, communication software is required on the PC side.)

Upgrade of Water Proof Characteristic

EMC Assessment P.103

The direct out type connection is applied for all models of CNC rotary table, and the EMC assessment is satisfied as the total system.

Digital Servo System & Absolute Encoder

Very excellent acceleration/deceleration characteristics, the powered up torque and the best suited servo parameter realize the high quality and long life.

 after Power ON or after releasing the emergency stop condition is not necessary.*

Plenty of Optional Functions

True Closed Loop, Manual Pulse Generator, M Function (Input: 5/ Output: 5), External N Number Search, External Position Display, External Power ON/OFF, Pitch Error Compensation

More than 30,000 sets working in the field.

This fact ensures the highest reliability.

Product compatible with ROHS2-10 commands

The AR21 controller is now ROHS2-10 compliant and has the product code AR21, which can be shipped to EU member countries.(400W,750W,1.3KW,1.8KW)

* : The operation to establish the coordinate system is required at once, when turning the POWER ON at first time just after connecting the cable. Please refer to  P.62



AR21 controller
 • Standard (400W, 750W)
 300×280×285 10kg
 • Single Phase AC200/220V



AR21 PW controller
 • Power up (1.3KW, 1.8KW)
 540×360×400 28kg
 • 3 phase AC200/220V



AR21 controller for larger capacity
 • 4.4KW is available.
 • 3 phase AC200/220V

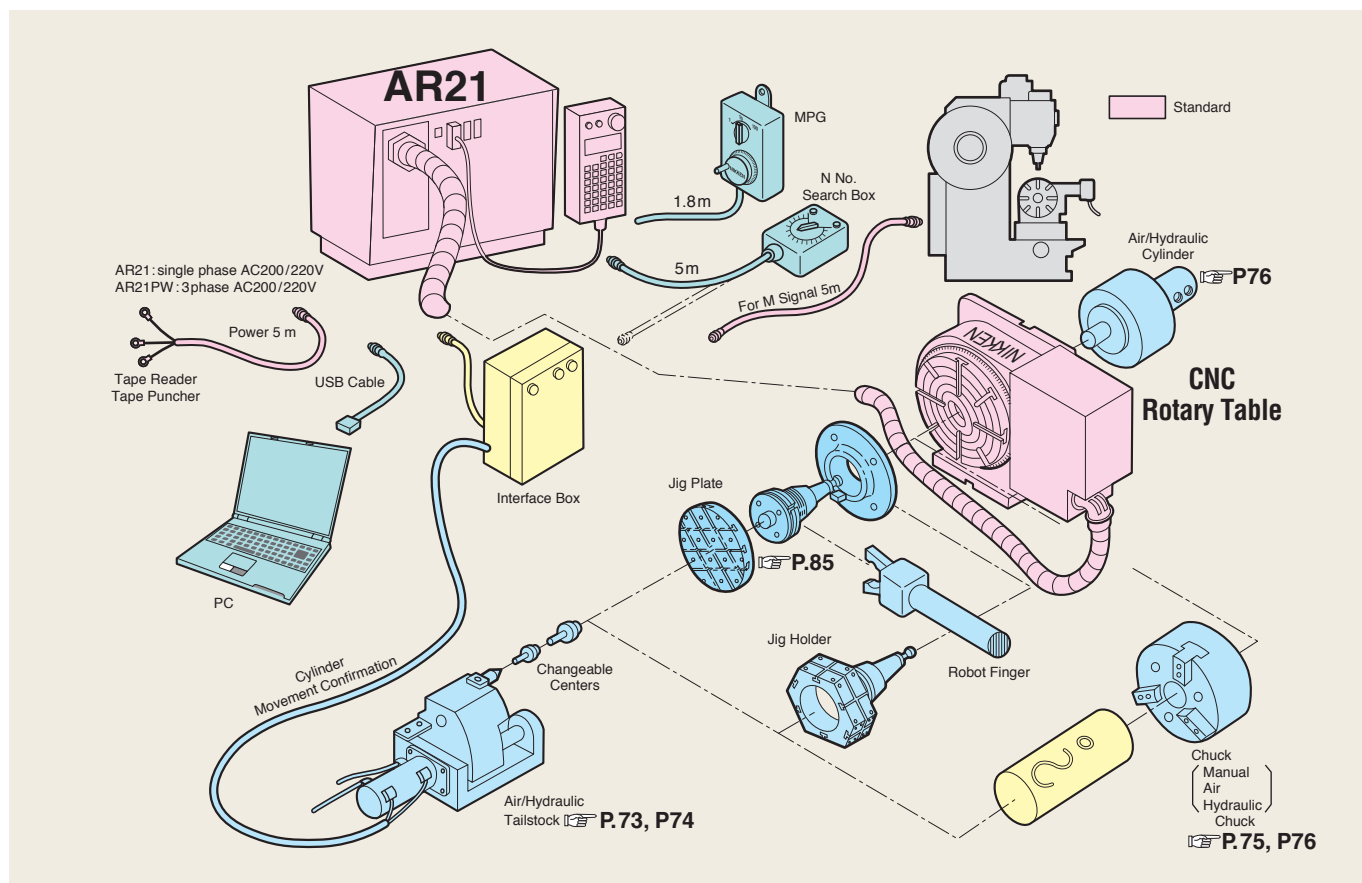

Main Specification of Controller (NIKKEN-AR21 controller)

Item	Specification	Remarks
MIN. Increment	0.001° or 1"	Free Selection
MAX. Programmable Angle	±9999 rotation, ±999.999° & ±999°59'59"	Free Selection
MAX. Equal Dividing	2~9999 equal dividing	
Program Capacity	1000 Blocks	N000~N999
Input System	MDI Key Board, Pendant type	
Programming System	Combined use of Incremental/Absolute	Free Selection of G91 / G90
Zero Return	Machine Zero Position/Work Zero Position	can be commanded from outside.
Manual Feed	Rapid Feed/Fine Feed/Step Feed/Continuous Feed	
Uni-directional Positioning	Uni-directional Positioning can be done to eliminate the mechanical backlash.	G14
Emergency Stop	Whole system stops	can be commanded from outside.
Feed Hold	Table rotation temporarily stops.	can be commanded from outside.
Jump Function	Jump to sub program etc.	
Repeating Function	By specifying start No. and final No., multiple sequence are repeated.	
Buffer Function	Reading next block, and execute job without stop.	Useful for lead cutting etc.
Dry Run	Table always rotates in rapid feed for checking.	
Key Lock Function	Even if operation button is pressed by mistake, such command is neglected for safety.	
Preparatory Function	Dwell, Clamping/Unclamping, Lead Cutting...	G04~G92
G1 Code, G2 Code	2 kind of G codes can be entered in one block.	
Block Data display	At programming, previous block data or next block data are displayed.	↑ ↓
USB Interface	Program data and parameters can be input and output.	
Software Limit Function	± stroke limit values can be set by parameter.	
Over Travel Detection Function	Over travel detection zone can be set at outside of software limit by using control circuit, and the CNC rotary table can be protected not to exceed safety zone.	Standard for 5AX- type tilting axis
Alarm No. Automatic Indication Function	When alarm is detected, controller automatically goes to diagnosis mode and Alarm No. is displayed.	When duplicated, it flickers every 2 sec.
Alarm Out	Alarm condition of AR21 can be sent to M/C	
Emergency Stop Out	Emergency stop condition of AR21 can be sent to M/C.	
Self Diagnosis Function	Inside situations of controller can be seen.	
Modal G Code Flicker Function	All G codes used in program are indicated in flickering.	Every 2 sec.
Pitch Error Compensation Function	Rotary axis: 15° unit, Tilting axis: 5° unit	Option
Feed Rate Override	5~200%,999% (Rapid feed)	±5%
Input Signals	1 kind of Auxiliary Function.(Automatic operation can be done by only one M signal.)	With or without contact signal *1
Output Signal	1 Block Finish signal, Work Zero Position Signal, Alarm Out Signal *2	Ask Time Chart
Servo Motor	AC servo motor with serial encoder	
Input Power	AR21 : Single phase AC200~220V, 50Hz / 60Hz	400W : 480VA*3, 750W : 760VA*3
	AR21 PW : 3 phase AC200~220V, 50Hz / 60Hz	1.3kW : 960VA*3, 1.8kW : 1.2KVA*3

*1: M signal of M/C is valid only the block without DEN (Distribution End).

*2: Work Zero Position Signal and Alarm Out Signal are optional signals.

*3 Input load capacity at 40% of average load factor.

OPTIONAL SPECIFICATION

- | | | | | |
|--|---|---|--|--|
| <p>1 True Closed Loop</p> <p>This is to be used for ultra precision rotary table.</p> | <p>2 Manual pulse generator (X1, X10, X100)</p> <p>This pulse generator enables the table to be rotate or tilted by manual operation on every 0.001~0.1° unit.</p> | <p>3 Five M functions</p> <p>Control and confirmation of other actuator (hydraulic tailstock, coolant controller, robot etc.) can be done from AR21 side. AR21 for AWC, this is included as standard.</p> | <p>4 External N Number Search Function</p> <p>When plural programs are entered in 1000 blocks. Desired N number can be searched from outside (applicable also to FMS line).</p> | <p>5 External Power ON/OFF</p> <p>Interface to perform Power ON/OFF by external circuit is available.</p> |
| <p>6 Pitch Error Compensation</p> <p>Rotary Axis:
by 15° unit x 24 points
Tilting Axis:
by 5° unit x 24 points
The optimum correction value is adjusted and shipped with increased indexing accuracy.</p> | <p>7 Output Signal *2</p> <p>Work Zero position signal is the signal set to ON while the CNC rotary table is in the work zero position. Alarm Out signal is the signal set to ON when AR21 is in alarm condition. These signals can be used for interlocking function.</p> | <p>8 Direct Angle Command Interface</p> <p>By connecting the machine side RS232C interface to the AR21 controller, it is possible to manage all the programs of the AR21 controller. For details, please refer to page 76.</p> | <p>9 Harting Connector Type</p> <p>Harting Connector can be corresponded to the CNC Rotary Table side. The AR21PW controller is not compatible.</p> | |



Explanation of PENDANT 1

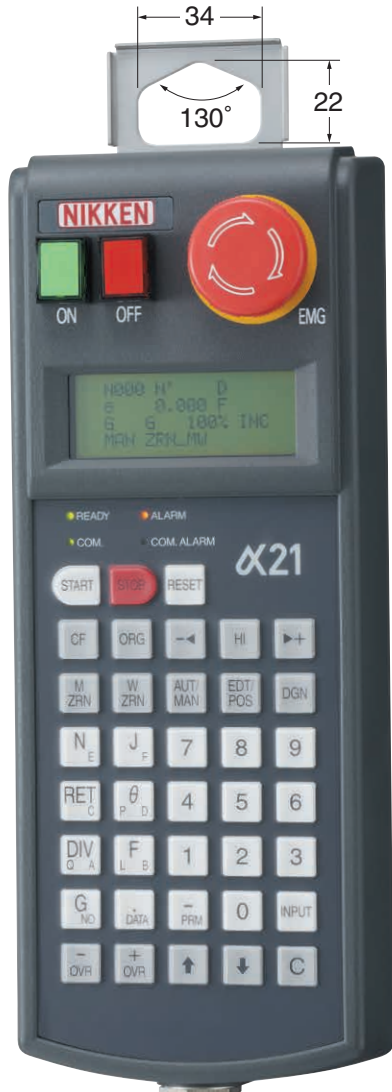

- ① Power Switch
- ② Emergency Stop Button
- ③④ Manual Jog Button
- ⑤ High Speed Button
- ⑥ Auto/Manual Select Switch
- ⑦ Edit/Current Position Select Switch
- ⑧ Start Button
- ⑨ Stop Button
- ⑩ Continuous Feed Button
- ⑪ Original Point Set Button
- ⑫ Machine Zero Return Button
- ⑬ Work Zero Return Button
- ⑭ Diagnosis Button
- ⑮ Increment/Decrement of Block No.
- ⑯ Feed Rate Override Button
- ⑰ Reset Key

- **READY** Turned ON when input power is supplied.
- **COM.** Turned ON while AR21 main unit and the pendant are communicating.
- **ALARM** Turned ON when AR21 is in alarm condition.
- **COM. ALARM** Turned ON when communication time out error occurs between AR21 main unit and the pendant.



① Power Switch

② Emergency Stop Button

③④ Manual Jog Button

▶ + Clockwise, - ◀ Counter clockwise.
While this button is being depressed, the table continually rotates slowly. When this button is depressed once, the table steps by 0.001°(1").

⑤ High Speed Button

When this button is depressed together with ③ or ④, the table rotates in rapid feed.
When jog ③ while depressing ⑤, table moves as following;

Gear Ratio	Table Movement	Gear Ratio	Table Movement
1 : 720	0.5°	1 : 90	4.0°
1 : 360	1.0°	1 : 60	6.0°
1 : 180	2.0°	1 : 45	8.0°
1 : 120	3.0°		

⑥ Auto/Manual Select Switch

When this button is turn to Manual, all buttons are workable.
When this button is turn to Auto, all other buttons except ①, ②, ⑥, ⑧, ⑨, ⑭, ⑰ are ineffective.

⑦ Edit/Current Position Select Switch

On θ of ⑱, programming or present position is displayed alternatively.

⑧ Start Button

The table rotates as programmed.

⑨ Stop Button

The table slows down and stops. (Feed Hold Function). When ⑧ is depressed again, the table rotates the remaining angle of the program.

⑩ Continuous Feed Button

When this button is depressed, the table rotates continually. And, when ⑨ is depressed, the table stops. The desired feed and direction are to be input in N997 Block. (Refer P.53 ⑧)

⑪ Original Point Set Button

When this button is depressed at any angle, the position display shows 000.000°, and it is used as the work zero position. When the cumulative angle becomes 360°, work zero position signal is sent, which can be used as interlock.

⑫ Machine Zero Return Button

When this button is depressed, the table returns to the machine zero position (0° of the graduation of the table) clockwise in rapid feed, then low speed for final positioning.

⑬ Work Zero Return Button

When this button is depressed, the table returns to the position set by ⑪ clockwise in rapid feed.

⑭ Diagnosis Button

⑮ Increment/Decrement of Block No.

Previous block data and next block data are displayed.

⑯ Feed Rate Override Button

POS mode : Increasing feed rate 5 to 200% every 5% → Rapid feed (999).

PRM mode : Displays the following parameters sequentially.

POS mode : Decreasing feed rate 200 to 5% every 5%.

PRM mode : Displays the proceeding parameters sequentially.

⑰ Reset Key

This is for calling N000 and also for resetting alarm display etc.

Explanation of PENDANT 2

18 Display

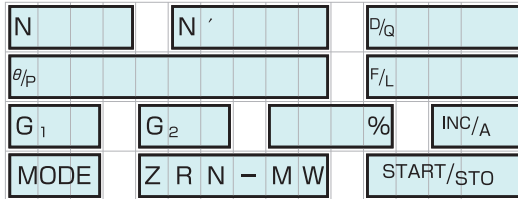

- N** : Sequence No. N000~N999
- NRS**: Direct angle command interface is selected.
- N'**: Jump & Return J000~J999, RET
- θ** : Rotation angle of table (Decimal, Sexagesimal)
0~±999.999° (Decimal)
0~±999.59'59" (Sexagesimal)
- D** : Equal division (divided by 2 to 9999)
- F** : Feed rate
Cutting feed: 0.01~9.99r/min
Rapid feed: 000
- G** : Preparatory function G01~G92
Two kind of G codes (G1, G2)
can be input in one block.
- %**: Feed rate override
(5% to 200%, or 999 for rapid feed rate)
- P** : Starting block No. of repeating function (G27)
- Q** : Final block No. of repeating function (G27)
- L** : Repeating frequency (G27)
- INC/ABS**: **INC** (Incremental)
ABS (Absolute)
- MODE**: **EDT** (Edit mode)
MAN (Manual mode)
AUT (Auto. mode)
MPG (MPG mode)
DGN (Diagnostic mode)
- ZRN-MW**:
M Flickering (Returning to M ZERO)
M (Stop at M ZERO)
W Flickering (Returning to W ZERO)
W (Stop at W ZERO)
- START/STOP** : **START** (Starting)
STOP (Stop)

19 Key Encoder

For calling a certain sequence, input the number after this key so that the program of the block is display, also you can start from the program.

This key is to be used when you want to call sub program N' or jump to N' after N block is completed.

When sub program is finished, enter R at 18 N' display. And, it returns to the block next to the one where J' was commanded in the main program.

θ : You can input 0° to ±999.999° in 0.001° increment, or 0° to ±999° 59'59" in 1" increment.

The selection of decimal or sexagesimal system is set up by parameter.
In case of Dwell Instruction (G04), the waiting time is inputted. (0.001 to ±999.999 sec.).

P : Starting number of repeating function (G27)
000 to 999.

DIV: Automatic equal dividing times 0 to 9999.
Lead cutting instruction (G07) 0 to 999.

Q : Final number of repeating function (G27)
000 to 999.



θ (±6~7digits)
P (3digits)



DIV (4digits)
Q (3digits)



F, L (3digits)



F : Cutting feed F001 (0.01 r/min) to F999 (9.99 r/min).
Rapid feed F000 or F0.

L : Repeating frequency 0 to 999.

- Without G : Positioning
- G04 : Dwell
- G06 : Constant acceleration
- G07 : Rotation number
- * G08 : Buffer commencing
- * G09 : Buffer ending
- * G10 : Brake unclamped
- * G11 : Brake clamped
- G14 : Uni-directional positioning
- * G15 : Droop check
- * G16 : Droop cancel
- G21 : Simultaneous start
- G22 : Continuous start
- G23 : Machine zero point return
- G24 : Work zero point return
- G27 : Repeating function
- G28 : Programmable machine Pzero position return
- * G90 : Absolute command
- * G91 : Incremental command
- G92 : Coordinate system setting

M Function (Option)

G60~G74 : Activate an actuator

How to enter G code :

0 cannot be suppressed for both G1 and G2 codes.
For example, when G1=07 and G2=08, enter them as follows;

G0708*

and indication will become as ;

G1	G2
07	08

When you want to enter 9°, just depress keys as **θ** → **9** → **.**, and 9.000° or 9°00'00" is displayed.



This is for command of Counter clockwise rotation.

This is depressed as programming of each block being completed.
(Hereafter shown as *****).

For deletion or alternation of θ, DIV, or F individually, just depress θ, DIV, or F, then depress. Also when you depress ***** with pressing **C**, complete one block is deleted.

Deleting successive blocks

For example, in order to delete blocks from **N000** to **N999**, push keys **N** **0** **←** **999** at Edit mode, and jog ***** while depressing **C** key.

***** means optional function.

Operation of the pendant of AR21 controller for tilting axis specification and for NSV index specification differs, please refer instruction manual.



Caution for AR21 Controller

- The alarm regarding the absolute encoder will be appeared, when turning the POWER ON at first time just after connecting the cable. This is because the coordinate system is not established yet. Please try as follows;

- **DGN** Return to pervious mode.
- **PRM** **DGN** **1** **.** **1** ***** PRM#110=1
Writing parameter value enable.
- **G** **7** **2** **.** **1** ***** PRM#72=1
- Turn the POWER OFF and ON
- For rotary axis **M** **ZRN** Execute machine zero return.
- For tilting axis First set the temporary machine zero position and **M** **ZRN**.
Please refer instruction manual for more detail.

- When the alarms regarding the absolute encoder such as ALARM#1101 or #1102 are appeared, please set PRM#71=1 and turn the POWER OFF and ON to establish the coordinate system again.

Operation & Confirmation of PROGRAMS



Before programming, be sure that mode is [EDT].

Before start the programs, push [F1]..... or [F2]..... in [EDT] mode, and confirm input date. Then start the program in [MAN] mode to confirm the moving.

Operation of Keys.

<p>① Angle Dividing</p>		<pre>N 0 0 0 G 0 4 5 . F 0 *</pre> <p>Input Angle</p> <p>Rapid feed.</p> <p>No need of pressing 0 under decimal point.</p> <p>Sequence No.</p>
<p>② Arc Milling</p>		<pre>N 0 0 0 G 4 5 1 2 3 F 1 2 3 *</pre> <p>123 x 1/100 r/min rotation speed. means 45.123° Cutting Feed : = 2 πR x 1.23 r/min = 7.7 R mm/min.</p>
<p>③ Equal Dividing</p>		<pre>N 0 0 0 J 0 G 4 5 . F 0 *</pre> <p>After finishing N000 return to N000.</p>
<p>④ Unequal Dividing</p>		<pre>N 0 0 0 G 4 5 . F 0 * 0 0 1 G 3 5 1 2 0 0 0 2 G 6 1 5 6 7 0 0 3 G 9 3 5 6 7 0 0 4 G 6 7 3 5 0 0 0 5 J 0 G 5 7 3 9 6</pre> <p>In case of the same feed rate in the following blocks just command once. (Modal type)</p> <p>After finishing N005 return to N000.</p>
<p>⑤ Incremental/ Absolute Dividing</p>		<pre>N 0 0 0 G 4 5 1 2 3 F 0 G 9 1 * 0 0 1 G 1 8 1 5 6 7 0 0 2 G 9 0 9 8 7 0 0 3 J 0 G 0 . N 0 0 0 G 9 0 *</pre> <p>Incremental Command (Modal Type)</p> <p>To W zero-point</p> <p>Absolute Command (Modal Type)</p>
<p>⑥ Repeating Function</p>		<pre>N 0 0 0 G 1 3 . F 0 * 0 0 1 G 1 4 . 0 0 2 G 1 8 . 0 0 3 G 2 7 P 0 DIV 2 F 2 *</pre> <p>L : Repeat 2 times</p> <p>θ : Starting N000</p> <p>Q : Finishing N002</p> <p>Command of repeating function</p> <p>• SUB-Program (J/RET) and Loop-Jump Function (G25) can be used. However, programming can be done more easily when Repeating Function (G27) is used.</p>
<p>⑦ Counter Clockwise Rotation</p>		<pre>N 0 0 0 G 4 5 . F 0 *</pre> <p>Counter Clockwise (CCW)</p>
<p>⑧ Continuous Feed 0.5</p>		<pre>N 9 9 7 G 0 . F 5 0 *</pre> <p>Continuous feed 0.5r/min (CCW)</p> <p>Command of continuous FeedStart</p> <p>Start</p> <p>Stop</p>
<p>⑨ Equal Dividing of Arc</p>		<pre>N 0 0 0 G 9 0 . DIV 1 3 F 2 0 0 * 0 0 1 G 1 1 2 . DIV 2 3 F 0 * 0 0 2 J 0 G 1 5 8 . DIV 1 1 * N 0 0 0 G 9 0 . F 2 0 0 *</pre> <p>This means 90°÷13. Feed rate can be commanded from 0.01 r/min to rapid speed.</p>
<p>⑩ Equal Dividing of Circle (360°)</p>		<pre>N 0 0 0 G 3 6 0 . DIV 9 1 F 0 * 0 0 1 G 3 6 0 . DIV 7 7 * 0 0 2 G 3 6 0 . DIV 1 1 1 * 0 0 3 G 3 6 0 . DIV 2 3 1 * 0 0 4 J 0 G 3 6 0 . DIV 1 2 3 1 *</pre> <p>91 Equal dividing of circle and go to N001 77 Equal dividing of circle and go to N002 111 Equal dividing of circle and go to N003 231 Equal dividing of circle and go to N004 1231 Equal dividing of circle and return to N000</p>
<p>⑪ M function</p>		<p>Optional Specification</p> <pre>N 0 0 0 G 6 0 0 0 1 G 3 6 0 . DIV 1 0 0 0 2 G 6 1</pre> <p>* Tailstock forward</p> <p>* Circle is equally divided into 10 sections.</p> <p>* Tailstock backward</p> <p>Example of automatic operation using M function. G62 on the rotary axis controller is M function to active the tilting axis controller for 5AX- table.</p>

M-SIGNAL

① Example for Circle Drilling & Tapping (23 equal division)

● Program of NC Machine

```

O 0000 ;...Main program
M 98 P 0100 L 23 ;...Drilling cycle 23 times
M 98 P 0101 L 23 ;...Tapping cycle 23 times
M 02 ;
O 0100 ;...Sub program 1
G 01 Z — ;...Drilling fixed cycle
M 21 ;
M 99 ;
O 0101 ;...Sub Program 2
G 01 Z — ;...Tapping fixed cycle
M 21 ;
M 99 ;
    
```

● Program of AR21

```

N 000 J 0 @ 360 ◻ DWI 23 F 0 *
    
```

23 equal dividing of 360°
After finishing N000, return to N000 again.



23 equal dividing on circle for drilling & tapping

When NC Machine executes the sub program 23 times, drilling & tapping of 23 holes is completed with 23 equal divisions calculated to 1/23rd of 360° to third decimal places automatically, e.g. 15.652°.

② Example for Arc Milling

● Program of NC Machine

```

O 0001 ;
M 21 ;
G 01 Z — ;...Z axis down
M 21 ;
G 00 Z — ;...Z axis up
M 21 ;
    
```

● Program of AR21

```

N 010 @ 210 ◻ F 0 G 91 *
    
```

Incremental command (Modal Type)
Rapid feed to starting point ①

```

O 11 @ 120 ◻ F 50 *
    
```

Milling by rotating speed of 0.5r/min

```

O 12 J 10 @ 30 ◻ F 0 *
    
```

30° of rapid feed to work zero position
After finishing N012, return to N010

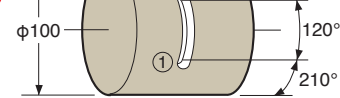

(Calculation of cutting speed)
 $100 \times \pi \times 50 \times 1/100 \text{r/min} = 157 \text{ mm/min}$

③ Example for Lead Cutting

● Program of NC Machine

```

O 0003 ;
M 21 ;
G 01 Z — ;...Z axis down
M 21 ;
M 21 ;
G 01 X 40. F 100 ; *1
G 00 Z — ;...Z axis up
M 21 ;
    
```

● Program of AR21

```

N 020 @ 240 ◻ F 0 G 91 *
    
```

Rapid feed to starting point ①

```

O 21 G 10 *
    
```

Brake unclamped

```

O 22 @ 79.338 F 55 G 21 *
    
```

Cutting feed to ②
Simultaneous start

```

O 23 J 20 @ 0 ◻ G 90 11 *
    
```

Rapid feed to work zero position
G90 (Absolute) & G11 (Brake clamped)

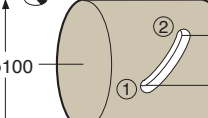

Fig. 1

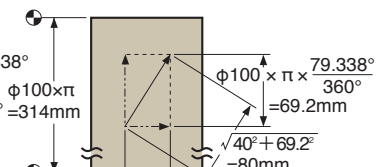

Fig. 2

Calculations for Feed Rate in Lead Cutting

1. Make a development elevation like Fig.2 to calculate the vector.
2. Give feed in lead cutting (cutting feed from ① to ②)....e.g. 200 mm/min (depend on work piece materials).
3. Cutting speed of X axis: $F_x = 200 \text{ mm/min} \times 40 \text{ mm} \div 80 \text{ mm} = 100 \text{ mm/min}$ F100 *1
4. Cutting speed of θ axis: $f = 200 \text{ mm/min} \times 69.2 \text{ mm} \div 80 \text{ mm} = 173 \text{ mm/min}$
 $173 \text{ mm/min} \times 1 \text{ r/min} \div 314 \text{ mm/min} = 0.55 \text{ r/min}$ F55 *2

④ Example of continuous rotation as turning operation

● Program of NC Machine

```

O 0004 ;
M 21 ; Start continuous rotation
X & Z Contouring
M 21 ; Stop continuous rotation
M 21 ; Machine zero position return with dog
    
```

● Program of AR21

```

N 030 G 22 *
    
```

Continuous rotation

```

N 031 J 30 G 28 *
    
```

Programmable machine zero position return with dog

```

N 997 @ 10 ◻ F 300 *
    
```

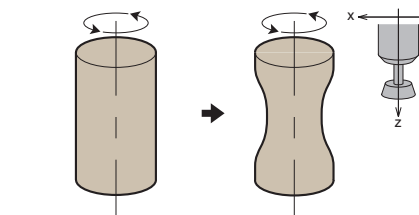

The direction and feed rate of continuous rotation are specified on N997. When higher rotation speed than standard is required, please contact with us.

CNC ROTARY TABLE with AR21 CONTROLLER



CNC105AR21-04

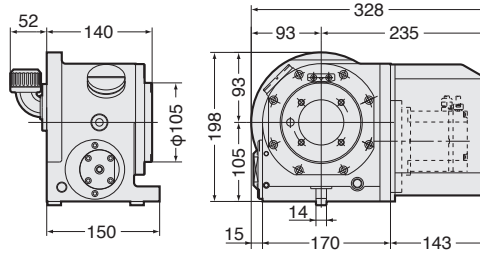

Powerful Clamping Torque : 205Nm

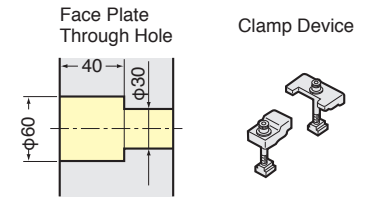

Air purge function is provided.

CNC180AR21-04



CNC180AR21-04 (400W) is standard. CNC180AR21-08 (750W) and CNC180AR21-06 (High Torque) are available.

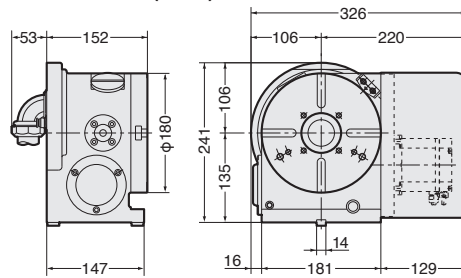

Powerful Clamping Torque : 303Nm

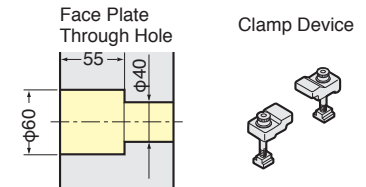

Air purge function is provided.

CNC202AR21-08



CNC202AR21-08 (750W) is standard. CNC202AR21-06 (High Torque) is available.

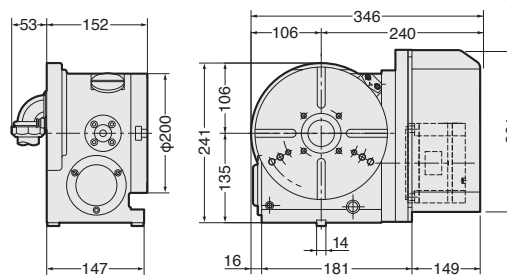

Powerful Clamping Torque : 303Nm

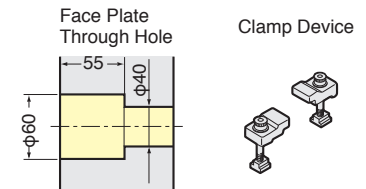

Air purge function is provided.

CNC205AR21-05



CNC205AR21-05 (450W) is standard. ★Built-in type rotary joint 6+1 can be mounted.

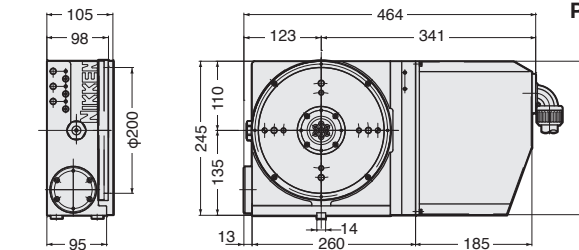

Powerful Clamping Torque : 380Nm

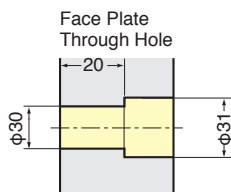

Air purge function is provided.

Rotary joint shown in photo is optional.

NCT200AR21-08



Powerful Clamping Torque : 900Nm

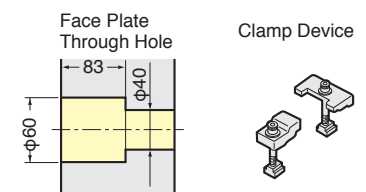
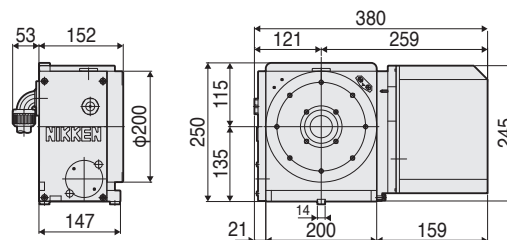

Air purge function is provided.

CNC260AR21-08, 302AR21-08

CNC260, 302AR21-08 (750W) is standard. CNC260, 302AR21-06 (High Torque) is available.

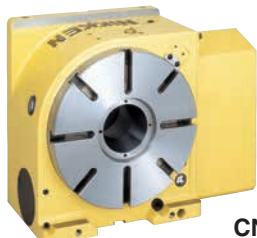

CNC260

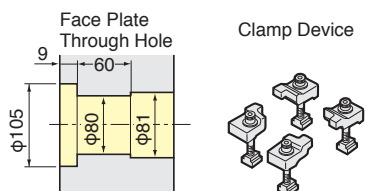
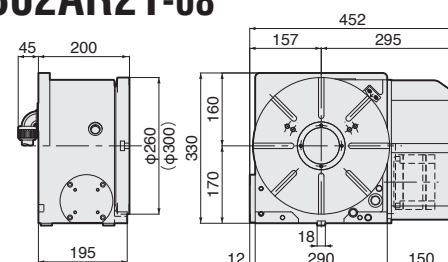

CNC ROTARY TABLE with AR21 CONTROLLER



CNC321, 401AR21-18

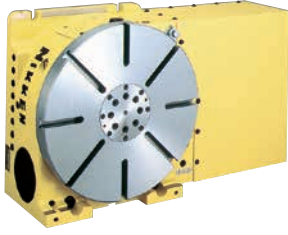

Rotary joint shown in photo is optional.

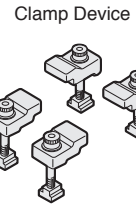
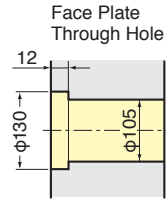
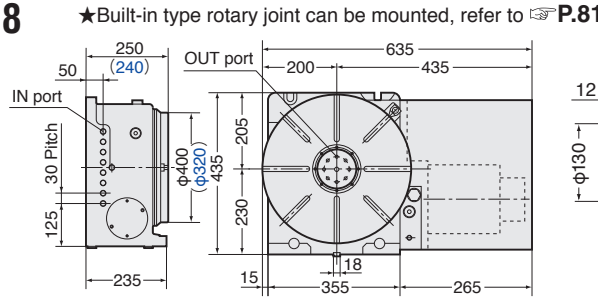

★ Please contact us for the dimension of CNC321AR21-18.

CNC501, 601AR21-18

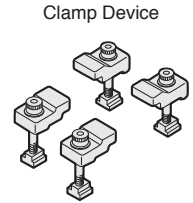
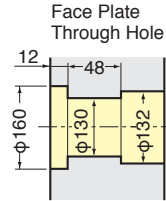
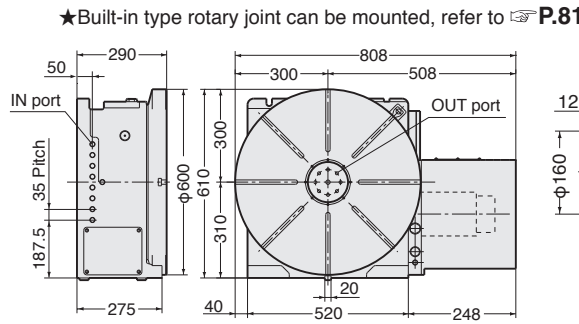
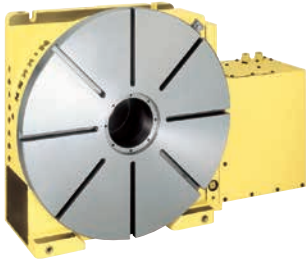

★ Please contact us for the dimension of CNC501AR21-18.

CNC1000, 1200AR21

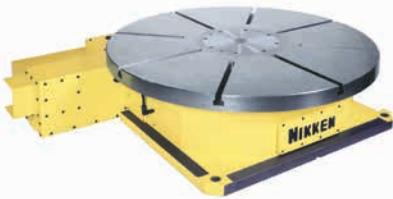

Center socket shown in photo is optional.

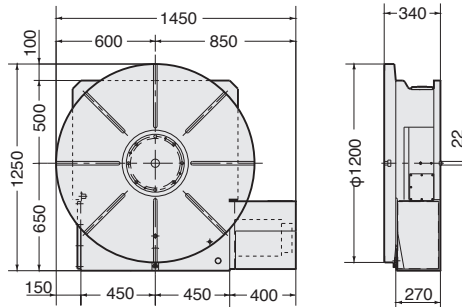

- ★ Ultra precision of $\pm 3\text{sec.}$ is available as an option. There is no through hole on the rotary table due to the rotary encoder for ultra precision option.
- ★ Please contact us for the dimension of CNC1000AR21.
- ★ Code No. will be varied according to the servo motor capacity. e.g CNC1000AR21-44 (4.4KW Motor)

CNC1201AR21

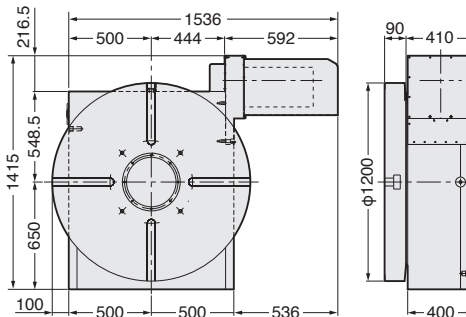
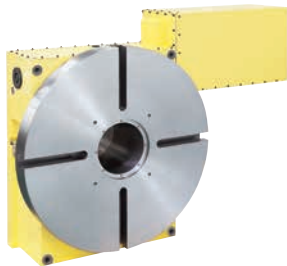

- ★ Ultra precision of $\pm 3\text{sec.}$ is available as an option. There is no through hole on the rotary table due to the rotary encoder for ultra precision option.
- ★ Please contact us for the dimension of CNC1000AR21.
- ★ Code No. will be varied according to the servo motor capacity. e.g CNC1201AR21-44 (4.4KW Motor)

CNC1600AR21

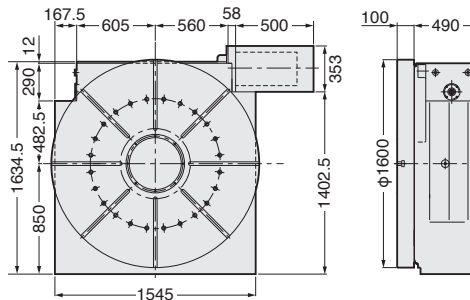
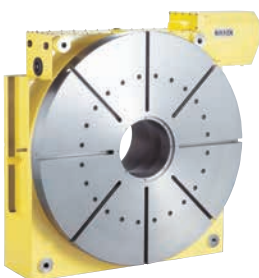

- ★ Ultra precision of $\pm 3\text{sec.}$ is available as an option. There is no through hole on the rotary table due to the rotary encoder for ultra precision option.
- ★ Please contact us for the dimension of CNC2000AR21.
- ★ Code No. will be varied according to the servo motor capacity. e.g CNC1600AR21-44 (4.4KW Motor)

The specification of the large rotary table will be varied according to your application.

1. With/without T slot, Width of T slot
2. Spindle hole dimension...Center socket for centering is normally installed.
3. Layout of the rotary table...Vertical use, horizontal use, vertical and horizontal use
4. Total reduction ratio...Suitable capacity of the servo motor can be selected.

Tilting Rotary Table with AR21 Controller



5AX-100WAR21

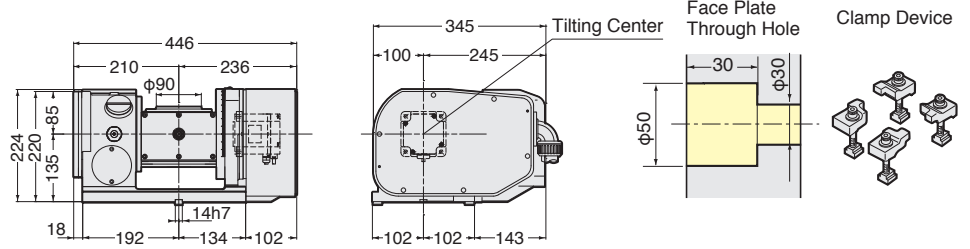

Motor capacity of rotary axis and tilting axis are added at the end of Code No. e.g 5AX-100WAR21-0404

5AX-130WAR21

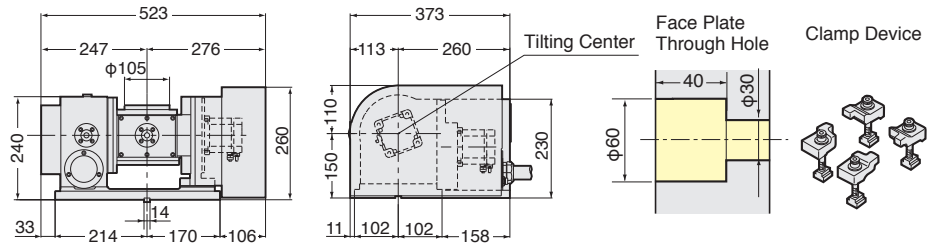
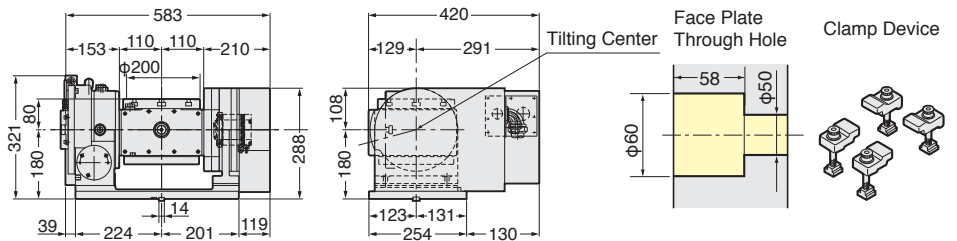

Photo with $\phi 130$ mm plate.
Rotary axis cable stays.

Motor capacity of rotary axis and tilting axis are added at the end of Code No. e.g 5AX-130WAR21-0404

5AX-201WAR21



Motor capacity of rotary axis and tilting axis are added at the end of Code No. e.g 5AX-201WAR21-0408

5AX-250WAR21

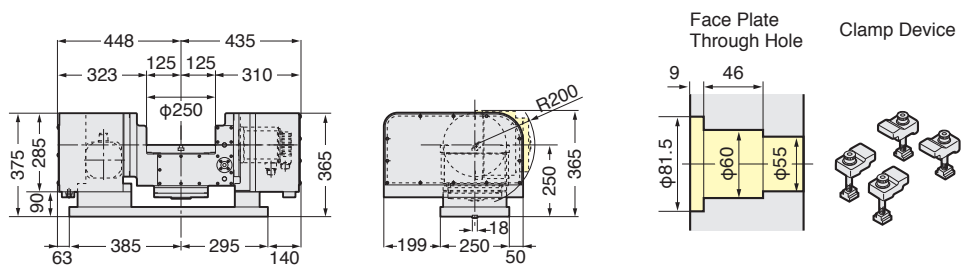

Motor capacity of rotary axis and tilting axis are added at the end of Code No. e.g 5AX-250WAR21-1313

5AX-350WAR21

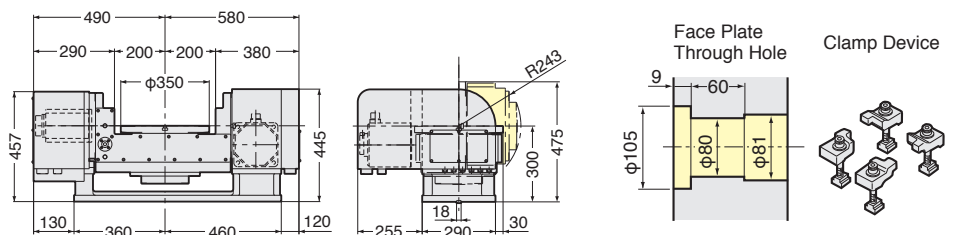

Motor capacity of rotary axis and tilting axis are added at the end of Code No. e.g 5AX-350WAR21-1318

M-SIGNAL

Tilting Rotary Table with AR21 Controller



5AX-550WAR21



Center socket shown in photo is optional.

The specification of the large rotary table will be varied according to your application.

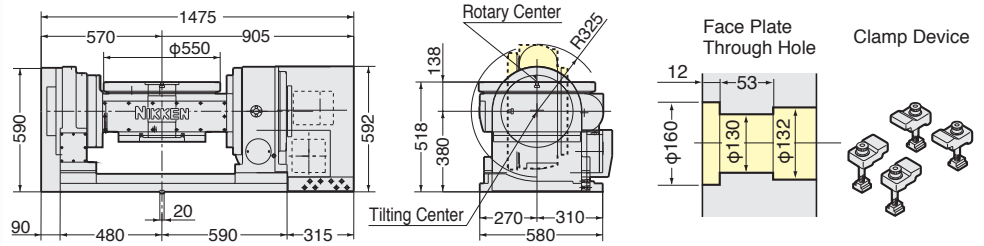

Motor capacity of rotary axis and tilting axis are added at the end of Code No. e.g 5AX-550WAR21-1818

5AX-800WAR21

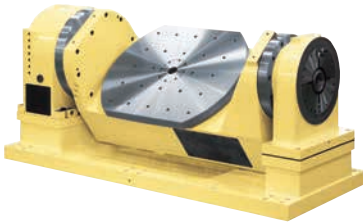

Motor capacity of rotary axis and tilting axis are added at the end of Code No. e.g 5AX-800WAR21-1844

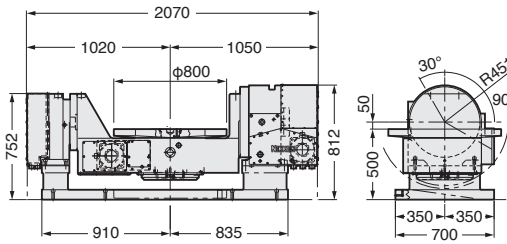

1. Moving angle of the tilting axis
2. Relation between the tilting axis center and the rotary axis



5AX-1200A: The tilting axis center is located in the same position as the center of the rotary axis body.



5AX-1200B: The tilting axis center is located in the same position as the top surface of the rotary axis.

3. Tilting axis base... It can be supplied to us.
4. With/ without T slot, Width of T slot
5. Spindle hole dimension
...Center socket for centering is normally attached.

5AX-1200BWAR21

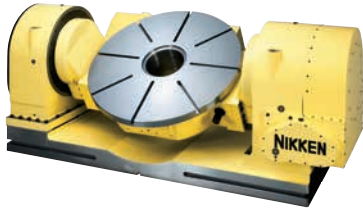

Motor capacity of rotary axis and tilting axis are added at the end of Code No. e.g 5AX-1200BWAR21-4444

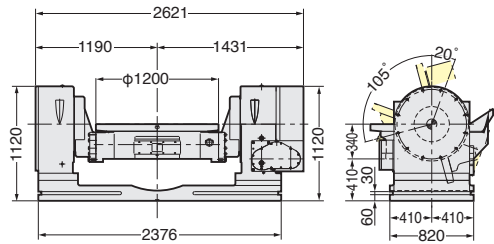

5AX-2MT-105WAR21



Motor capacity of rotary axis and tilting axis are added at the end of Code No. e.g 5AX-2MT-105WAR21-0404
If you need a knock hole for positioning or a key way on the table surface, please contact us.

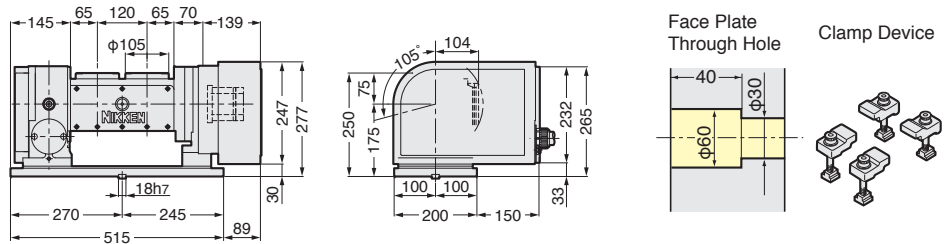

AR21 controller can drive the all models of NIKKEN rotary tables. Please contact us for the external dimension.



Back side motor mounted CNC rotary table



Top side motor mounted CNC rotary table



Multi-spindle CNC rotary table

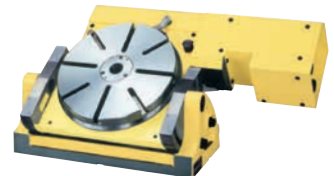

NST manual tilting rotary table



NSVZ index

Indexing of MIN. incremental of 1° is done by AR21 controller.



NSVX rotary index table

AR21 controller can perform indexing of MIN. 1° with hirth coupling and can also perform indexing of MIN. incremental by 0.001° and profile milling.

AR21 controller connection

Normally the controller will be operated only by connecting M Signal (Start Signal) and 1 Block Fin. Signal. Emergency Stop Input must be set to B contact only for 5AX-Tables. For other Tables, you can choose A/B contact for Emergency Stop Input.

When to be connected to machine, receptacle MS3102A18-1P is provided. Arrange the electric circuits of your machine side.

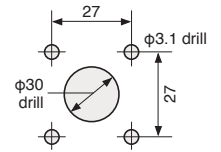

Mounting dimensions

Input/Output Time Chart

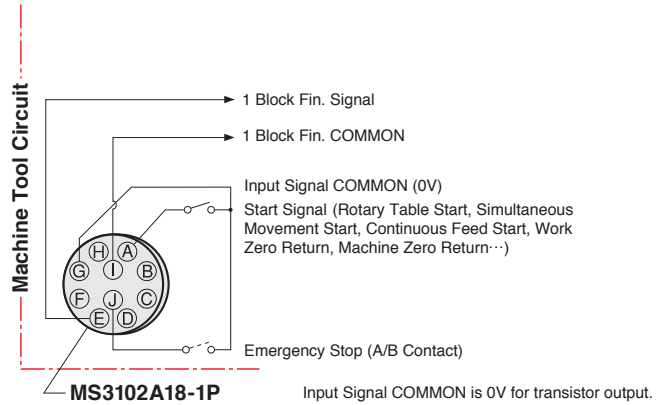
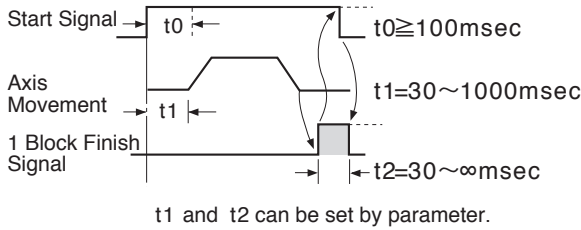

Connection for Automatic Operation

Once program is loaded to AR21, all operations such as Power ON, Machine Zero Return, Program Section, Start etc. can be done by machine side. 3 sets of M signals are required for CNC rotary table and 6 sets of M signal are required for 5AX- tilting rotary table. e.g.

- M21** : Start Signal
- M22** : Program Jump (Selection) Signal
- M23** : Machine Zero Return and Reset

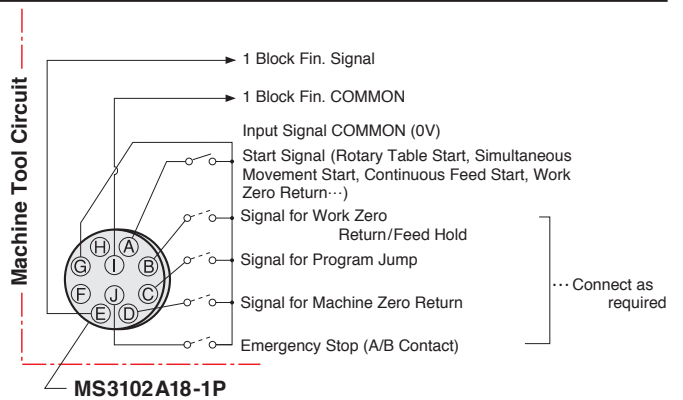

RS232C Automatic Loading Interface. ... Pendant is to be used for manual operation and maintenance only. (OPTION)

Program is loaded from Custom Macro of M/C, and start the program by the ordinary M signal. Total management of programs can be done on only M/C side. The necessary functions of M/C side are;

- Custom Macro
- Custom Macro External Output Function
- 2 sets of M signals

- e.g.
- M21** : Start signal
 - M24** : Start signal of RS232C Automatic Loading Function (Start signal without 1 Block Fin. signal confirmation and keep this signal ON at least 100msec.)

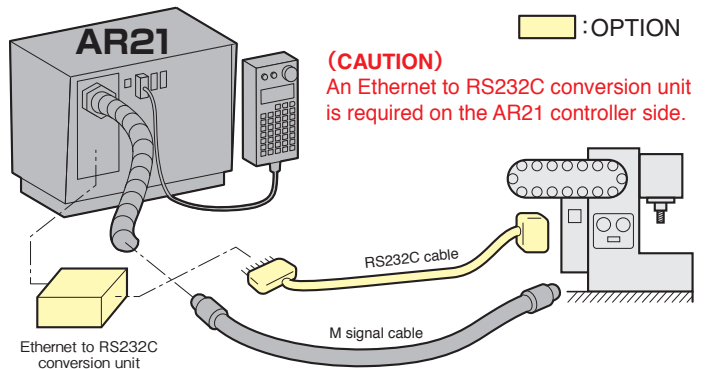

```
M/C Main Program
e.g. Machining of Imperial Blade
O0001;
G65 P8000;
...
G01 Z_;
X300;
Y_Z_M21;
X0;
Y_Z_M21;
X300;
...
```

X0. X300.



```
Macro Program
(Down Loading to AR21)
O8000;
M24; Activate AR21 automatic loading function.
POPEN;
#100=165;
BPRNT[#100[0]];
DPRNT[N10 G90 A22.149];
...
#100=165;
BPRNT[#100[0]];
G04 P3000; Dwell 3sec.
PCLOS;
M66;
```

Send %,CR,LF.
 Send block data.
 Send %, CR,LF.

⚠ N No. must be specified on each block data.

RS232C Direct Angle Command Interface (OPTION) JAPAN PAT.

This interface can start the block after sending one block data from custom macro of M/C. Equal dividing function (e.g. divided by 7) also can be sent. Therefore, program will be simple and more accurate and the total management of the programs can be done only on M/C.

Required functions at the M/C

- (Custom macro
- (Custom macro external output function
- (1 M signal (Start signal) **M21**

5AX-table with 2 off AR21 controllers can be connected to use RS232C direct angle command interface. In this case, special RS232c cable is required and 2 off M signals are required.

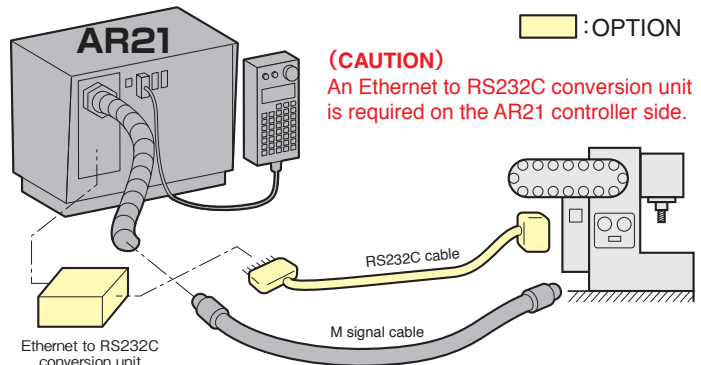

(CAUTION)

An Ethernet to RS232C conversion unit is required on the AR21 controller side.

: OPTION

Pendant is to be used for manual operation and maintenance only.

RS232C interface

The cable is available as an option.

Baud rate : 9600 bps

Code : ISO

Data bit length : 7 bits

Parity bit : Even parity

Stop bit length : 2 bits

Parameter setting of M/C must be "LF CR" or "CR LF" is sent at EOB sending.

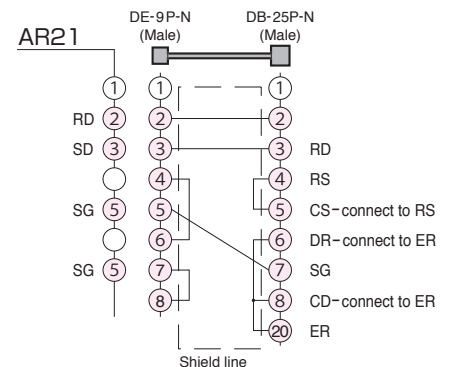
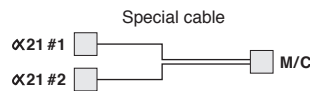

Call off macro program for direct angle command

G65 P8000 M _____ A _____ E _____ F _____ D _____ ;

ID No. (can not be omitted.)
Please specify the value of PRM #1 on AR21.

Feed rate 000,001~999

Number of equal dividing

Angle command (can not be omitted. **A** : Rotary axis, **B** : Tilting axis)

90/91 = Absolute/Incremental

M21(start) will be executed as required times after execution of macro program for direct angle command.

Macro program for direct angle command (Example for only rotary axis control)

```

O 8000;
POPEN;
#100=165;
BPRNT [#100[0]];
IF [#13 EQ #0] GOTO 5;
IF [# 8 EQ #0] GOTO 3;
IF [# 9 EQ #0] GOTO 2;
N1 DPRNT [ID#7[10] G#13[20]A#1[43]E#8[40]F#9[30]];
GOTO 10;
N2 DPRNT [ID#7[10] G#13[20]A#1[43]E#8[40]];
GOTO 10;
N3 IF [#9 EQ #0] GOTO 4;
DPRNT [ID#7[10] G#13[20]A#1[43]F#9[30]];
GOTO 10;
N4 DPRNT [ID#7[10] G#13[20]A#1[43]];
GOTO 10;
N5 IF [#8 EQ #0] GOTO 7;
IF [#9 EQ #0] GOTO 6;
DPRNT [ID#7[10] A#1[43]E#8[40]F#9[30]];
GOTO 10;
    
```

```

N6 DPRNT [ID#7[10] A#1[43]E#8[40]];
GOTO 10;
N7 IF [#9 EQ #0] GOTO 8;
DPRNT [ID#7[10] A#1[43]F#9[30]];
GOTO 10;
N8 DPRNT [ID#7[10] A#1[43]];
N10 BPRNT [#100[0]];
G04 P200;
P CLOS;
M99;
    
```



Work zero position signal and alarm out signal can be output as an option. Be careful that these signals are non-contact type output and output common line is 0V. These signals must be received on the relay. Please contact with us for more details.

Termination of the maintenance work for NIKKEN controllers

The maintenance work of the NIKKEN controllers is continued as long as the electric parts could be supplied. However, about the following controllers, the maintenance has to be terminated, because the supply of the electric parts became impossible. Please examine reshuffling to the CNC rotary table with AR21 controller by all means.

Terminated at April 2005 : ND5000, 8000DC, 8800DC, 9000DC
 Terminated at April 2005 : NSV controller (M signal I/F, B signal I/F)
 Terminated at April 2013 : 8800DX, 8800AX, 8AC
 Terminated at April 2021 : NEC alpha controller

SUPPORT TABLE

Table Model	Center Height	W/O Clamping	With Clamping		Slim Support Table With Clamping
			Air (0.5MPa)	Hyd. (3.5MPa)	
CNC105	105	CST100-105	TAT-105N		
CNC180, 202,205	135	CST100-135	TAT-170N		TAS-100N
NCT200	135	CST100-135	TAT-170N		TAS-100N
CNC180B, 202B	180		TAT-170N*1		TAS-100N*1
CNC260, 302 CNC260P, 302P	170	TAT-250N(Shared use Air/Hyd)			
		TAT-200N(Shared use Air/Hyd)*2			
CNC321	230			TAT-321N	
CNC401	230			TAT-401N	
CNC321T	240			TAT-321N*4	TAT-403N
CNC401T	240			TAT-401N*4,403N	TAT-403N
CNC501, 601	310			TAT-501N	
NSVZ180	135		TAT-170N		
NSVZ300	170	TAT-250N(Shared use Air/Hyd)			
		TAT-200N(Shared use Air/Hyd)*2			
NSVX400	240			TAT-401N*4	
DD251	170		TAT-170N*3		

*1 : A separate sub-base is required to align the center height.

*2 : The center height is possible to increase 20mm to use sub-base.

*3 : The support tables that can be used are subject to limitations based on the number of rotations.

*4 : When a sub-base is used to adjust the center height, a +10 mm variation in the specification can be accommodated.

Compact Support Table

CST100-105, 135

(W/O Clamping System)

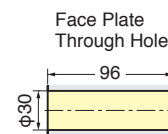
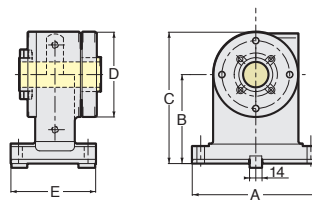

Code No.	A	B	C	D	E	Weight(kg)
CST100-105	150	105	155	100	100	7
CST100-135	150	135	185	100	100	8

Compact & Slim Support Table

TAS-100N

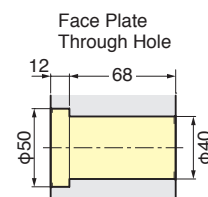
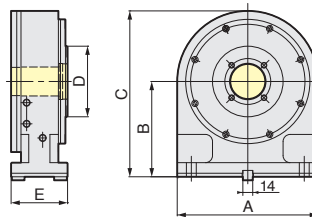

Code No.	A	B	C	D	E	Clamping System	Clamping Torque(N·m)	Weight(kg)
TAS-100N	200	135	235	100	80	Pneumatic	217	17

Slim Support Table

TAT-403N

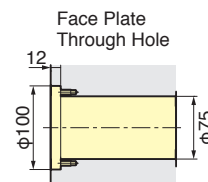
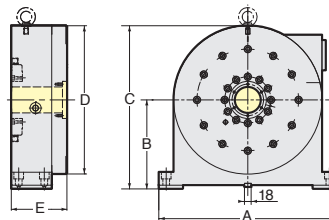

The table without T slots "N" is standard.

T slots are available (optional)

Code No.	A	B	C	D	E	Clamping System	Clamping Torque(N·m)	Weight(kg)
TAT-403N	480	240	440	400	150	Hydraulic	1500	155

★ Pneumatic ports: 2 x Rc1/8 Solenoid, Clamp-Unclamp switches are not included.

★ Hydraulic connections are RC3/8 X 2 and pneumatic connections are RC1/8 X 2. Confirmation switches for clamp/unclamp and solenoid valve are not included.

★ Hydraulic pressure is 3.5MPa. Air pressure is 0.5MPa.

★ Rotary joint is available for all models. **P.81**

★ Please add "— center height" at the end of Code No. for the support table with different center height (B) . e.g. TAT321-240 (For CNC321T)

Support Table

TAT-105N

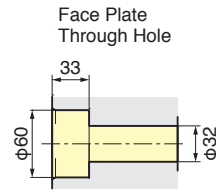
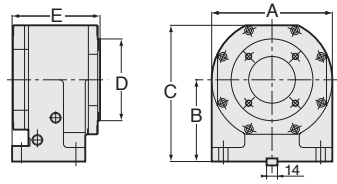
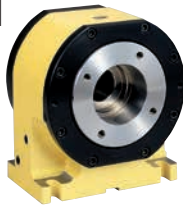

Without T-slots "N" (standard) / With T-slots (optional) in case of **TAT-105**

Code No.	A	B	C	D	E	Clamping System	Clamping Torque(N·m)	Weight(kg)
TAT-105N	155	105	175	105	113	Pneumatic	205	16

TAT-170N

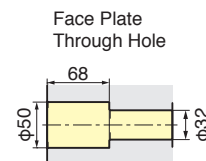
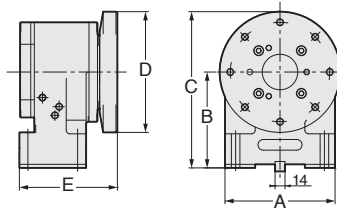

Without T-slots "N" (standard) / With T-slots (optional) in case of **TAT-170**

Code No.	A	B	C	D	E	Clamping System	Clamping Torque(N·m)	Weight(kg)
TAT-170N	155	135	220	170	138	Pneumatic	205	25

TAT-200N, 250N

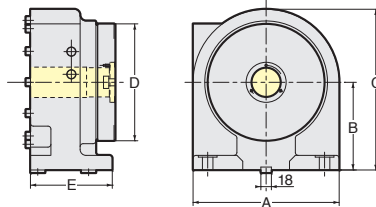

TAT-200N



TAT-250N

The table without T slots "N" is standard. T slots are available (optional)

Code No.	A	B	C	D	E	Clamping System	Clamping Torque(N·m)	Weight(kg)
TAT-200N	250	150	275	200	145	Pneumatic / Hydraulic	112/784	43
TAT-250N	250	170	295	250	145	Pneumatic / Hydraulic	112/784	50

★TAT-200N is used in combination with **CNC321T** or **CNC401T** to install lifting-block.

TAT-321N, 401N, 501N

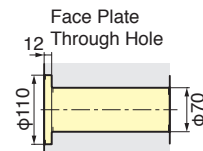
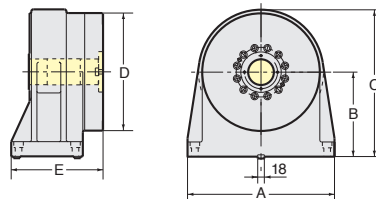
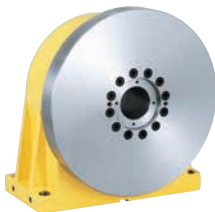

The table without T slots "N" is standard. T slots are available (optional)

Code No.	A	B	C	D	E	Clamping System	Clamping Torque(N·m)	Weight(kg)
TAT-321N	400	230	400	320	250	Hydraulic	1470	120
TAT-401N	400	230	430	400	250	Hydraulic	1470	140
TAT-501N	480	310	560	500	250	Hydraulic	1470	220

TAILSTOCK (MANUAL, PNEUMATIC, HYDRAULIC)

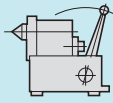
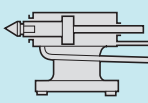
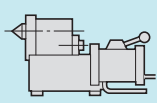

Tailstock

Table Model	Tailstock Tailstock illust	Manual	PNEUMATIC / HYDRAULIC	HYDRAULIC
		Stroke: 15mm 	Stroke: 60mm 	Stroke: 100mm 
Center Height				
CNC105	105	P-105S	PBA-105	
CNC180, 202	135	P-125S	PBA-135	
NCT200	135	P-125S	PBA-135	
CNC180B, 202B	180	P-170S	PBA-180	H-170S
NST250	155	P-150S		H-150S
CNC260, 302, 260P, 302P	170	P-170S	PBA-170	H-170S
CNC321, 401	230	P-230S		H-230S
CNC501, 601	310	P-310S		
NST300	208	P-210S		H-210S
NST500	288	P-280S		
5AX-100	135	P-125S	PBA-135	
5AX-130	150	P-150S	PBA-150	H-150S
5AX-201	180	P-170S	PBA-180	H-170S
5AX-230	240	P-230S		H-230S
5AX-250*	250			
5AX-350	300	P-310S		
CNC100-2, 3, 4W	105		PB-105-2,3,4W	
NSVZ180	135	P-125S	PBA-135	
NSVZ300	170	P-170S	PBA-170	H-170S
NSVX400	240	P-230S		H-230S

*Please contact us about the Tailstock for 5AX-250.

Manual Tailstock

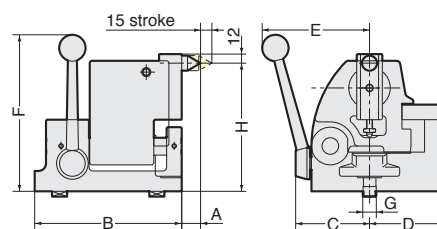

The center height can be adjusted.
Please refer to Center Height H on the table.

Code No.	Center Height H	A	B	C	D	E	F	G	Weight (Kg)
P-105S	102~110	27	150	76	74	120	195	14	10
P-125S	130~140	27	150	76	74	120	210	14	11.5
P-150S	145~160	25	195	98	102	145	210	18	22
P-170S	160~180	25	195	98	102	145	210	18	22.5
P-210S	200~220	25	195	98	102	145	250	18	26.5
P-230S	220~240	25	195	98	102	145	250	18	27
P-280S	280~300	15	235	103	124	145	330	20	41
P-310S	300~320	15	235	103	124	145	330	20	41.5

★Left hand type is available for all models. ★For P-150S or larger size tailstocks, 5 pcs of changeable centers are included. ★Live center can be applied.

Changeable Center

Code No.	FIG	A	B	C
PC-2	I	25		
PC-3	I	50		
PC-4	II		30	18.45
PC-5	II		40	28.45
PC-6	II		50	38.45

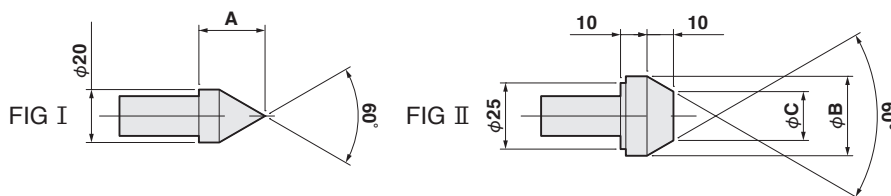

TAILSTOCK (MANUAL, PNEUMATIC, HYDRAULIC) **NIKKEN**

Pneumatic / Hydraulic both usable Small Size Tailstock

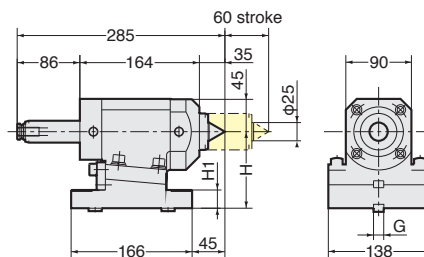

The center height can be adjusted within 0.35mm.

Code No.	Center Height H	H ₁	G	Thrust (N)		Weight (Kg)
				Pneumatic. 0.5MPa	Hydraulic. 2MPa	
PBA-105	105	25	14	1176	4733	15
PBA-135	135	55	14	1176	4733	20
PBA-150	150	70	18	1176	4733	22
PBA-170	170	90	18	1176	4733	24.5
PBA-175	175	95	18	1176	4733	25
PBA-180	180	100	18	1176	4733	25.5

★Rotary center is built-in. ★MT (Morse Taper) type quill is also available. Please contact with us.

★The different length of the stroke is available. Please contact us.

Pneumatic / Hydraulic both usable for Multi-Spindle Tailstock

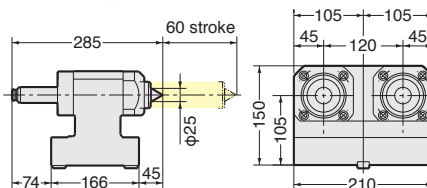

Code No.	Center Height H	H ₁	G	Thrust (N)		Weight (Kg)
				Pneumatic. 0.5MPa	Hydraulic. 2MPa	
PB-105-2W	105	25	18	1176	4733	28
PB-105-3W						42
PB-105-4W						55

★For fitting metal and stepped guide piece, refer to P.78

★MT (Morse Taper) type quill is also available. Please contact us.

★The stroke 60mm can be changed. Please contact us.

Hydraulic Tailstock

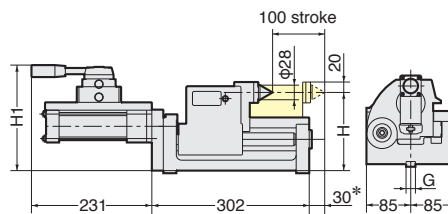

The center height can be adjusted.
Please refer to Center Height H on the table.

Code No.	Center Height H	H ₁	G	Thrust (N)	Weight (Kg)
				Hydraulic. 3.5MPa	
H-150S	145~160	191	18	5370	28
H-170S	160~180	211	18	5370	35
H-210S	200~220	251	18	5370	41
H-230S	220~240	271	18	5370	45

★Rotary center is built-in.

MAX. work piece diameter must be smaller than φ130mm, when the stroke of changing the work piece is more than 30mm marked *.

SCROLL CHUCK



Chuck Plate

Scroll Chuck



Holes for bolts of Front Mounting

Scroll Chucks with chuck plate marked * are NIKKEN Scroll Chuck of Front Mounting (Fig.1)

NIKKEN Scroll Chuck is used for X-4B, X-6E & X-9F.

The chuck plates for the scroll chucks without * can be used for the scroll chuck based on JIS B6151 SC/TC standard.

Scroll Chuck & Chuck Plate

Chuck Size	Range	
	External	Internal
4"	2~ 89	36~ 78
5"	3~104	42~ 92
6"	3~135	52~119
7"	3~153	56~134
9"	4~190	64~169
10"	10~229	72~208
12"	10~258	82~238

This is the actual gripping range not jaw stroke.

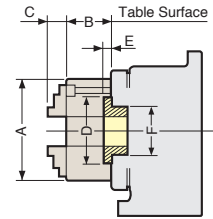

Fig.1

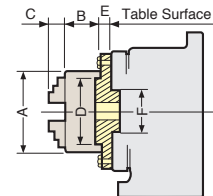

Fig.2

Front End Dimensions with Scroll Chuck & Chuck Plate

Table Model	Chuck Size	Chuck Plate	A	B	C	D	E	F	Fig. No.
CNC105	R-4	X-4B	112	58	31.25	80	13	60	2
CNC180	R-5	X-5C*	132	60	37.25	100	3.5	60	1
	R-6	X-6B*	167	66	44.25	130	4	60	1
CNC202	R-5	X-5C*	132	60	37.25	100	3.5	60	1
	R-6	X-6B*	167	66	44.25	130	4	60	1
CNC260, 260P	R-6	X-6G*	167	66	44.25	130	4	80	1
	R-7	X-7L*	192	75	46.25	155	4	80	1
CNC302, 302P	R-9	X-9H	233	82	55.25	190	25	80	2
	R-6	X-6G*	167	66	44.25	130	4	80	1
CNC321	R-7	X-7L*	192	75	46.25	155	4	80	1
	R-9	X-9J	233	82	55.25	190	18	80	2
CNC401	R-7	X-7N	192	75	46.25	155	16	105	2
	R-9	X-9K	233	82	55.25	190	18	105	2
CNC501, 601	R-10	X-10G	274	86	53.25	230	20	105	2
	R-12	X-12F-1	310	92	59.25	260	25	105	2
NST250, 300	R-7	X-7K	192	75	46.25	155	16	105	2
	R-9	X-9G	233	82	55.25	190	20	130	2
NST300	R-10	X-10D	274	86	53.25	230	20	105	2
	R-12	X-12G	310	92	59.25	260	20	105	2
NST500	R-9	X-9D	233	82	55.25	190	20	130	2
	R-10	X-10	274	86	53.25	230	20	130	2
5AX-100	R-12	X-12B	310	92	59.25	260	20	130	2
	R-5	X-5B	132	60	37.25	100	16	60	2
5AX-130	R-6	X-6A	167	66	44.25	130	16	60	2
	R-7	X-7B	192	75	46.25	155	16	60	2
5AX-201	R-9	X-9A	233	82	55.25	190	18	60	2
	R-10	X-10B-1	274	86	53.25	230	25	60	2
5AX-230	R-12	X-12A-1	310	92	59.25	260	25	60	2
	R-7	X-7G	192	75	46.25	155	18	75	2
5AX-250	R-9	X-9B	233	82	55.25	190	18	75	2
	R-10	X-10C	274	86	53.25	230	20	75	2
5AX-350	R-12	X-12	310	92	59.25	260	20	75	2
	R-4	X-4D*1	112	58	31.25	80	3	40	1
NSVZ180	R-4	X-4B	112	58	31.25	80	13	60	2
	R-4	X-4B	112	58	31.25	80	13	60	2
NSVZ300	R-5	X-5C*	132	60	37.25	100	3.5	60	1
	R-6	X-6B*	167	66	44.25	130	4	60	1
NSVZ400	R-7	X-7A*	192	75	46.25	155	4	60	1
	R-6	X-6B*	167	66	44.25	130	4	60	1
NSVZ500	R-7	X-7A*	192	75	46.25	155	4	60	1
	R-9	X-9F	233	82	55.25	190	20	60	2
NSVZ600	R-7	X-7M	192	75	46.25	155	16	80	2
	R-9	X-9J	233	82	55.25	190	18	80	2
NSVZ700	R-10	X-10E-1	274	86	53.25	230	25	80	2
	R-12	X-12D-1	310	92	59.25	260	25	80	2
NSVZ800	R-6	X-6E	167	66	44.25	130	15	60	2
	R-6	X-6A	167	66	44.25	130	16	60	2
NSVZ900	R-7	X-7B	192	75	46.25	155	16	60	2
	R-9	X-9A	233	82	55.25	190	18	60	2
NSVZ1000	R-10	X-10B-1	274	86	53.25	230	25	60	2
	R-7	X-7D	192	75	46.25	155	16	80	2
NSVZ1100	R-9	X-9C	233	82	55.25	190	18	80	2
	R-10	X-10A	274	86	53.25	230	20	80	2
NSVZ1200	R-12	X-12C	310	92	59.25	260	20	80	2

★The maker of the scroll chuck was changed. This table shows the chuck plate of the new maker. Please refer to CAT NO.8168 or older for the chuck plate of the old maker.

★The dimension from the table surface to the jaw is; [*]:B+C Others: E+B+C *1: Jig-plate with φ120 (AX101R075) is required.

- ① Power Chuck
- ② Rotary Cylinder
- ③ Chuck Adapter
- ④ Cylinder Adapter
- ⑤ Connecting Rod

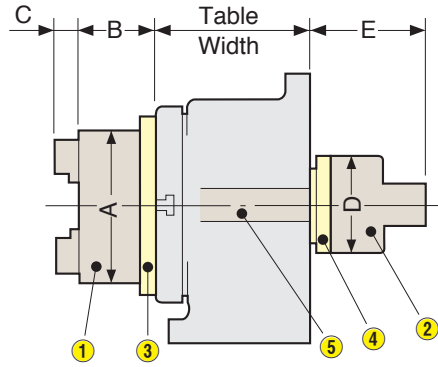

When power chuck or rotary cylinder is installed on 5AX-table, the 5AX-table must be High Column type.

● Power chuck Code No.

HO1MA

Serration pitch S : 1.5
 Chuck size : 3

Power Chuck & Rotary Cylinder

Table Model	Power Chuck Code No.	Pneu. Rotary Cylinder / Hyd. Rotary Cylinder	A	B	C	D	E	Table Model	Power Chuck Code No.	Pneu. Rotary Cylinder / Hyd. Rotary Cylinder	A	B	C	D	E	
CNC105	HO1MA-4	H05CH-100	110	70	27	115	215	5AX-100H 5AX-130H	HO1MA-4	Please ask for the detail.	110	70	27	-	-	
		HH4C-80				130	220							-	-	
CNC180	HO1MA-4	H05CH-100	110	70	27	115	215	5AX-201H 5AX-230H	HO1MA-4		110	70	27	-	-	
		HH4C-80				130	220		HO1MA-5		135	70	27	-	-	
	H05CH-150	135	70	27	115	215	HO1MA-6(S)		165		94	43	-	-		
	HH4C-80				186	235	-		-							
CNC202	HO1MA-4	H05CH-100	110	70	27	115	215	5AX-250H	HO1MA-6(S)		165	94	43	-	-	
		HH4C-80				130	220		HO1MA-8(S)		210	110	43	-	-	
	H05CH-150	135	70	27	115	215	HO1MA-6(S)		165		94	43	-	-		
	HH4C-80				186	235	-		-							
NCT200	HO1MA-4	H05CH-100	110	70	27	115	215	5AX-350H	HO1MA-8(S)		210	110	43	-	-	
		HH4C-80				130	220		HO1MA-10(S)		254	120	43	-	-	
	H05CH-150	135	70	27	115	215	5AX-2MT-105H		HO1MA-4		110	70	27	118	120	
	HH4C-80				186	235	5AX-4MT-105		HO1MA-4		110	70	27	98	115	
CNC260 CNC260P	HO1MA-6(S)	H05CH-175	165	94	43	135	240	NSVZ180	HO1MA-4		H05CH-100	110	70	27	115	215
	HO1MA-8(S)	HH4C-100	210	110	43	160	250		HO1MA-4		HH4C-80	110	70	27	130	220
CNC302 CNC302P	HO1MA-6(S)	H05CH-175	165	94	43	135	240	NSVZ300	HO1MA-5	H05CH-150	135	70	27	115	215	
		HH4C-100				210	240		HO1MA-6(S)	HH4C-80	135	70	27	186	235	
	HO1MA-8(S)	H05CH-250	210	110	43	160	250		HO1MA-6(S)	H05CH-175	165	94	43	135	240	
	HO1MA-10(S)	HH4C-125	254	120	43	290	295		HO1MA-6(S)	HH4C-100	165	94	43	210	240	
CNC321, 401	HO1MA-8(S)	H05CH-250	210	110	43	160	250	NSVZ300	HO1MA-8(S)	H05CH-175	165	94	43	135	240	
		HH4C-125				290	295		HO1MA-8(S)	HH4C-100	165	94	43	210	240	
	HO1MA-10(S)	H05CH-300	254	120	43	160	250		HO1MA-10(S)	H05CH-250	210	110	43	160	250	
	HO1MA-12(S)	HH4C-140	304	140	53	340	310		HO1MA-10(S)	HH4C-125	254	120	43	290	295	
CNC501, 601	HO1MA-8(S)	H05CH-250	210	110	43	160	250	NSVX400, 500	HO1MA-8(S)	H05CH-300	254	120	43	160	250	
		HH4C-125				290	295		HO1MA-10(S)	HH4C-125	254	120	43	340	310	
	HO1MA-10(S)	H05CH-300	254	120	43	160	250		HO1MA-12(S)	H05CH-300	304	140	53	180	260	
	HO1MA-12(S)	HH4C-140	304	140	53	340	310		HO1MA-12(S)	HH4C-140	304	140	53	340	310	
CNC-100-2 (3, 4)W	HO1MA-4	H05CH-100	110	70	27	115	215	-	-	-	-	-	-	-		
		HH4C-80				130	220	-	-	-	-	-				

★HOWA power chucks and rotary cylinders (Higher: Pneu, Lower:Hydraulic) are listed. Other maker's one can be mounted, please specify the Code No.

★Above power chucks are not applicable to NST Table. Please contact with us for mounting.

★NIKKEN air/hydraulic rotary cylinder is also available.

★For the specifications of power chuck and rotary cylinder, please refer to material of HOWA MACHINERY, LTD.

⚠ The additional machining may be necessary for the mounting of the power chuck after shipping. Please inform us when ordering, if the power chuck will be mounted after shipping.

ACC

Clamping device list by CNC rotary table model

Code No.	Guide-piece width of CNC rotary table (mm)	Clamping device shape1 Code No.	Quantity	Clamping device shape2 Code No.	Set	Thickness of the sim plate (mm)
CNC105	14	CLA114	1	CLE13	1	5
CNC180	14	CLA214	2	-	-	-
CNC202						
NCT200	14	CLA214	2	-	-	-
CNC180B	18	CLB18	2	CLC18	2	-
CNC202B						
CNC202T	14	CLB14	2	CLC14	2	5
CNC260, 260P	18	CLB18	2	CLC18	2	5
CNC302, 302P						
CNC260B	18	CLB18	2	CLD18	2	5
CNC302B						
CNC321(B)	18	CLB18	2	CLC18	2	10
CNC401(B)						
CNC501	20	CLA118	4	-	-	20
CNC601						
CNC350	18	CLB18	2	CLC18	2	10
CNC450	18	CLA118	4	-	-	10
CNC100 (Mult spindle)	18	CLA118	4	-	-	5
CNC180 (Mult spindle)	18	CLA218	4	-	-	-
CNC202 (Mult spindle)						
NST250	16 W-16B Stepped	CLA218	3	-	-	3
NST300	18	CLA118	3	CLB18(CLC18)	1	3
NST500	20	CLA118	4	-	-	-
5AX-100	14	CLA214	4	-	-	-
5AX-130	14	CLB14	2	CLC14	2	-
5AX-150	14	CLB14	2	CLC14	2	-
5AX-201	14	CLA114	4	-	-	-
5AX-230	18	CLB18	2	CLC18	2	-
5AX-250	18	CLA218	4	-	-	15
5AX-550	20	CLA118	4	-	-	20
5AX-2MT-105	18	CLA118	4	-	-	-
NSVZ180	14	CLA114	2	-	-	-
NSVZ300	18	CLB18	2	CLC18	2	5
NSVX400	18	CLA118	4	-	-	10

★ ★ CLD18 is what makes additional processing on CLC18, width: from 55 to 50mm

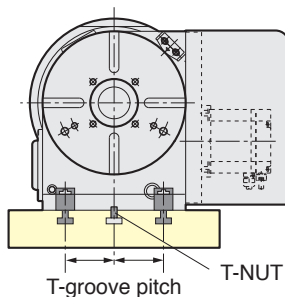

CLAMPING DEVICE is designed for T-slot pitches of 100mm or 125mm on the machine bed table. Please contact with us for the other pitches.

CLAMPING DEVICE and T-NUT



Code No. of Clamping Device

Size of clamping device bolt	Clamping Device Type				
	A1	A2	B	C	E
M12	CLA114	CLA214	CLB14	CLC14	CLE13
M16	CLA118	CLA218	CLB18	CLC18	CLE18
M20	CLA120	CLA220	CLB20	CLC20	CLE20

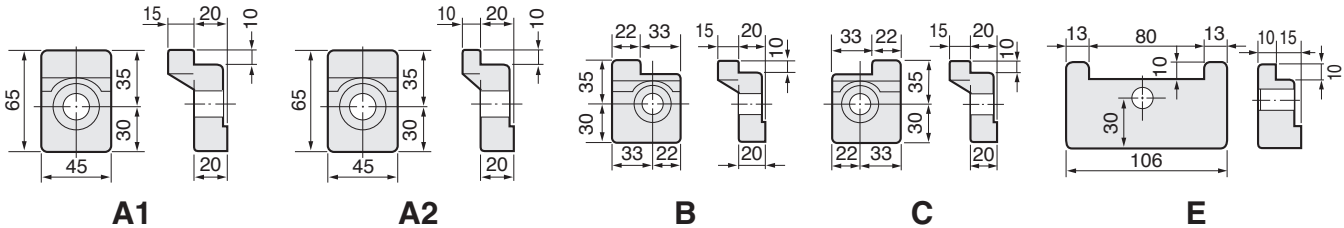

★ Clamping Devices (Fitting Metals) for the following CNC Table Models are Not Included. If necessary, consult NIKKEN sales person.
 CNC400H, CNC503H, CNC802, CNC803, CNC1000, CNC1002, CNC1200, CNC1201, CNC1600,
 5AX-800, 5AX-1200, 5AX-T400, 5AX-N400 and 5AX-B450T.

Standard Guide Piece

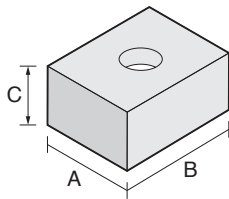

Key width dimension	A × B × C	Code No.
14	14 × 18 × 9	W141809
16	16 × 20 × 10	W162010
18	18 × 25 × 10	W182510
20	20 × 30 × 14	W203014
22	22 × 40 × 14	W224014

Stepped Guide Piece

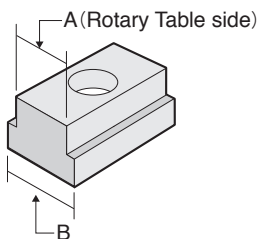

A \ B	10	12	14	16	18	20	22	24	7/16"	11/16"
14	W-14I	W-14H		W-14A	W-14B	W-14C			W-14F	W-14G
18		W-18E	W-18A	W-18B		W-18C	W-18D			
20				W-20A	W-20B		W-20C	W-20D		

★ The item is a set of two each.

● Please note that clamping device is altered when using stepped guide-piece.

TAP HOLES POSITION at the BOTTOM OF ROTARY TABLE

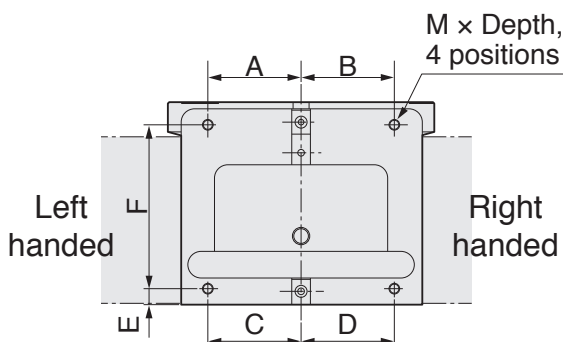

● Please refer to the above dimensions for direct mounting with the bolts from base plane side.

Table Model	A	B	C	D	E	F	M × Depth, 4 positions
CNC105, 105L	55	55	55	55	10	125	M10×12L, 4positions
CNC180, 202 CNC180L, 202L	70	70	70	70	12	123	M 8×10L, 4positions
CNC205	85	85	85	85	15	60	M10×15L, 4positions
NCT200	70	70	70	70	12	123	M 8×15L, 4positions
CNC260, 302 CNC260P, 302P	105	120	105	120	12.5	167.5	M12×16L, 4positions
CNC260L, 302L CNC260PL, 302PL	120	105	120	105	12.5	167.5	M12×16L, 4positions
CNC321, 401	145	135	165	135	15	200	M12×20L, 4positions
CNC321L, 401L	135	145	135	165	15	200	M12×20L, 4positions
CNC501, 501L	240	240	240	240	20	235	M16×30L, 4positions

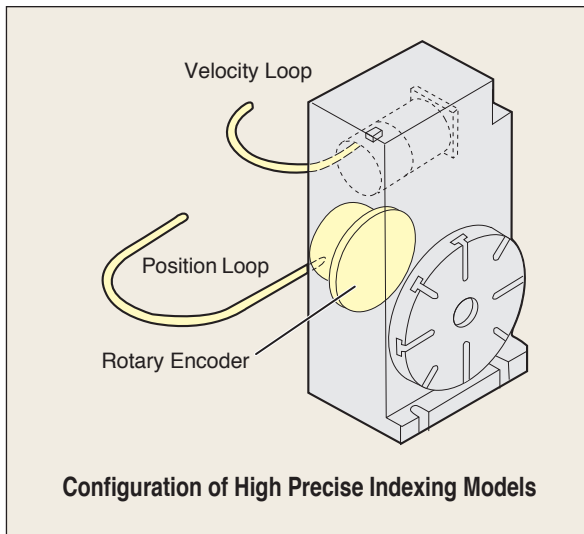

Full closed loop control becomes possible by mounting a rotary encoder at the back of rotary table. And high precise indexing becomes possible by detecting the rotary angle of the table directly.

★ In case indexing unit of 1" or very high rigidity is required, please select Hirth Coupling Index **NSVZ, NSVX** series table. **P.33**

★ Cables are not included in ultra precision option. Please order separately.

★ Air purge of the encoder inside is available as an option for water proof. Please contact us.

★ Encoders from other encoder manufacturers can also be installed. Please contact us separately.

The ultra-high precision specification refers to a CNC rotary table that has been finished to ultra-high precision after installing a Magnescale rotary encoder and performing precise calibration. This product is available on additional axis control of FANUC NC.

CNC For CNC Rotary Table

Ultra-High precision

Table Model	Indexing Accuracy Maker	±2"	±3"	±5"	
		Magnescale	Heidenhain	Magnescale	Heidenhain
CNC105, 180, 202, NCT200		—	—	RU97-2048A	RCN2391
CNC260, 302, 260P, 302P		MSE-RULT97	RCN8591	RU97-2048A	RCN2391
CNC321, 401, 501, 601, 802, 803		MSE-RULT97	RCN8591	RU97-2048A	RCN8391
CNC1000~1600		—	RCN8591	RU97-2048A	RCN8391

5AX For Tilting Rotary Table

Ultra-High precision

Table Model, axis	Indexing Accuracy Maker	Rotary	Tilting	Rotary		Tilting	
		±2"	±4"	±5"		±10"	
		Magnescale		Magnescale	Heidenhain	Magnescale	Heidenhain
5AX-130,201,-250		—	—	RU97-2048A	RCN2391	RU97-2048A	RCN2391
5AX-350		MSE-RULT97	MSE-RULT97	RU97-2048A	RCN2391	RU97-2048A	RCN2391
5AX-550-800		—	—	—	RCN8391	—	RCN8391

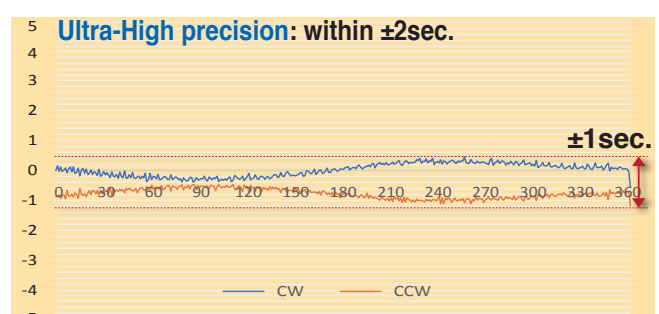
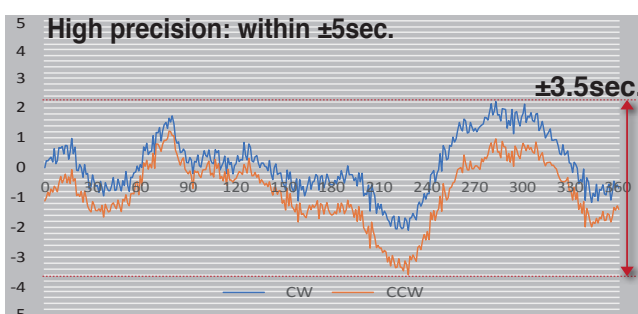

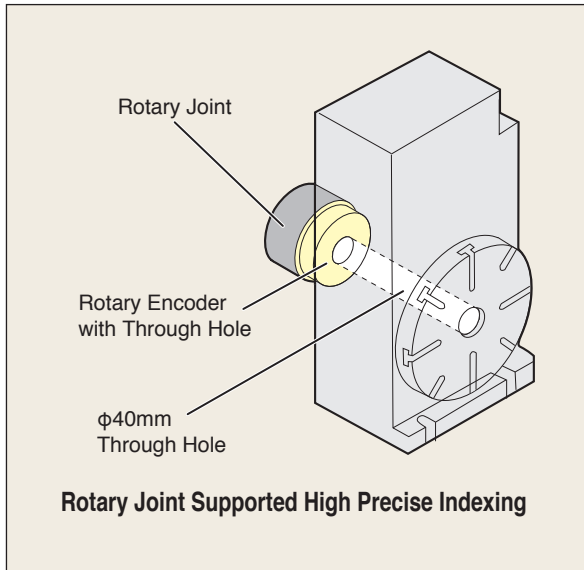

Rotary Joint Supported High Precise Indexing

- Even the number of IN ports is limited, rotary joint can be installed for the rotary table with the rotary encoder for high precision indexing. Please contact us.
- The rotary table with RCN8391 or RCN8591 has $\phi 40\text{mm}$ through hole, and the rotary joint can be mounted.

CNC High Precise Indexing with Through-hole for CNC Rotary Table

Table Model	Indexing Accuracy	$\pm 3''$	$\pm 5''$
		Rotary Encoder	Rotary Encoder
CNC260, 302, 260P, 302P		RCN8591	—
CNC321~1600		RCN8591	RCN8391

5AX High Precise Indexing with Through-hole for Tilting Rotary Table

Table Model		Indexing Accuracy	$\pm 5''$	$\pm 10''$
			Rotary Encoder	Rotary Encoder
5AX-550, 800	Rotary		RCN8391	—
	Tilting		—	RCN8391

ISO230-2 : Accuracy Measurement Based on International Standard (OPTION)

Accuracy Measuring Method Rotating Axis: $30.2^\circ \times 12$ points Tilting Axis: $15.2^\circ \times 8$ points

Continually repeating 5 times rotation of CW/CCW, measuring are to be done at above-mentioned points.

And, bidirectional accuracy of positioning, bidirectional repeatability of positioning, unidirectional accuracy of positioning, unidirectional repeatability of positioning etc. are calculated.

Test data sheet is available in English.

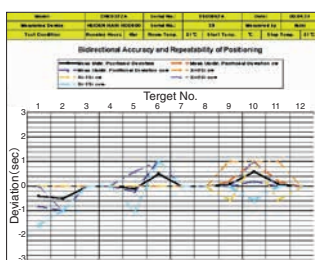

Bidirectional Accuracy and Repeatability of Positioning

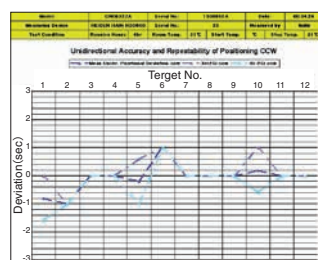

Unidirectional Accuracy and Repeatability of Positioning

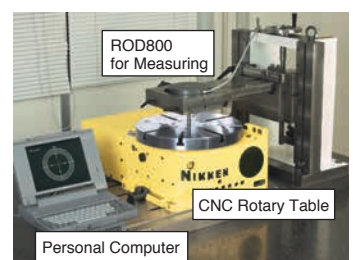
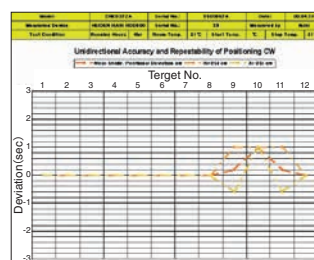

ROTARY JOINT

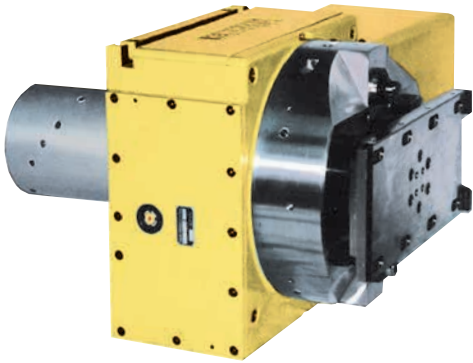

Rotary Joint is a rotating connector to supply air, hydraulic pressure or coolant liquid from outside to a fixture on a CNC rotary table. If liquid is supplied with ordinary hoses, twisting will happen on them by rotation of the table. However, rotary joints can solve this problem as it rotates in accordance with the table.

- Provides Pneumatic, hydraulic pressure or coolant from the rear of the table to a fixture.
- Automation of clamping/unclamping workpieces becomes possible.
- With a choice of 3 types: Cylinder type, Flange Plate type and Built-in type

- ★The coolant port is recommended to be separated because that the fine cutting swarf may come through the filter into the coolant port.
- ★The cylinder type rotary joint is equipped with a port in the center bore exclusively for the coolant liquid.
- ★Even the number of IN ports is limited, rotary joint can be installed for the rotary table with the rotary encoder. Please contact us.

The Examples of How Rotary Joint is Used

Rotary joint is used for clamping/unclamping workpieces, confirmation of proper clamp, cleaning, coolant etc.

Automation Application Examples With Pallet Clamp Unit

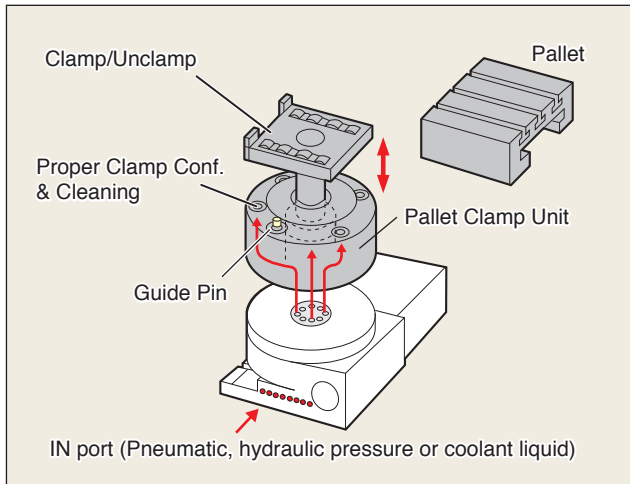

Automation Application Examples With Swing Clamp Unit

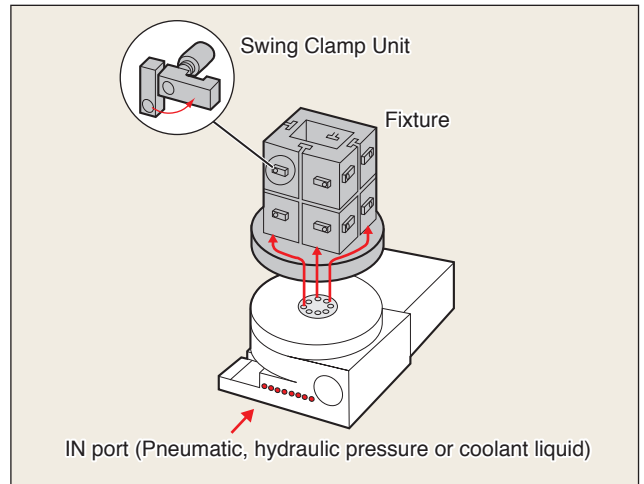

Type of Rotary Joint

1 Cylinder type Rotary Joint

- Cylinder type rotary joint allows many ports.
- Cylinder type rotary joint can be mounted later.

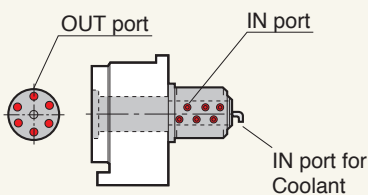

★The cylinder type rotary joint is useful in machining with the coolant liquid, because it's equipped with a port exclusively for the coolant liquid.

2 Flange Plate type Rotary Joint

- Flange plate type rotary joint reduces supply block projections
- IN ports position can be changed at any side: front, back, left or right side.

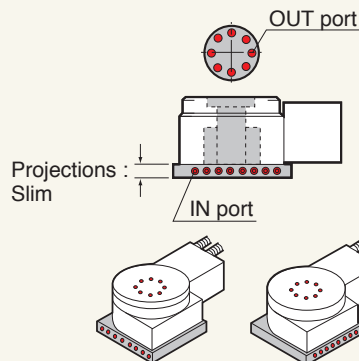

★The every position which causes no interference against M/C can be selected.
★Flange plate type rotary joint is useful in NSV series.

3 Built-in type Rotary Joint

- The highest space efficiency of all models of rotary joints
- Built-in type rotary joint can be mounted without changing dimension.

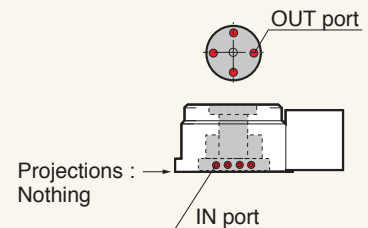

O/P

CNC Rotary Joints for CNC Rotary Tables

Code No.	Cylinder type	Flange Plate type		Built-in type
	MAX. Number of Ports	MAX. Number of Ports	T*(mm)	MAX. Number of Ports
NCT 200	6+1	6	39	—
CNC 105	6+1	4	25	—
180, 202	6+1	6	25	—
205	—	—	—	6+1
260, 302, 260P, 302P	10+1	11	60	—
(260B, 302B)	—	8+1	—	—
321, 401, 400H	12+1	—	—	8+1
B350	16+1	—	—	—
B450	20+1	—	—	—
503H	12+1	—	—	12+1
501, 601	14+1	15*6	—	8+1
802	16+1	—	—	10+1
NSVZ 180	6+1	5	25	—
300	8+1	6	30	—
400, 500	12+1	13	50	—

Rotary Joints for Support Tables

Code No.	Cylinder type	Flange Plate type		Built-in type
	MAX. Number of Ports	MAX. Number of Ports	T*(mm)	MAX. Number of Ports
TAT- 105, 170	6+1	2	25	—
200, 250	9+1*1	7	30	—
321, 401, 501	14+1	8+1	35	—

*1 MAX Number of Ports is 8+1P for TAT-200.

5AX Rotary Joints for Tilting CNC Rotary Tables

Code No.	MAX. Number of Ports on Main Unit	Cylinder type	Flange Plate type		Built-in type
		MAX. Number of Ports	MAX. Number of Ports	T*(mm)	MAX. Number of Ports
5AX- 100	—	(4)	3	25	—
130	—	2 (4)	—	—	—
201	4	4 (6)	—	—	4*2
250	3	—	—	—	3*3
350	6	—	—	—	6+1*4
550	4	10*5	—	—	—
800	6	—	—	—	6
DD251	—	—	6	30	—
DD402	—	—	8	30	—
5AX-DD201A,B	—	—	4	—	—

★ () : MAX No. of high column table.

★“+1” is the port located in the center hole for coolant.

* “T” is dimension of supply block projections after mounting rotary joints.

*2 : 4 reserve ports are provided on 5AX-201.

*3 : 3 reserve ports are provided on 5AX-250 and 2 external ports are available.

*4 : 6reserve ports are provided on 5AX-350. No additional port is available.

*5 : 4 reserve ports are provided on 5AX-550 as standard, and the additional 6 ports are available.

*6 : It becomes correspondence of a special use.

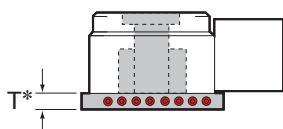

⚠ Caution of IN port

- When the air is supplied for all IN ports, please contact us.
- Please do not supply the different pressure of the air in the IN ports next each other.
- Please make sure that the line filter should be provided for pneumatic supply use in order to avoid swarf and water ingress for rust problem.
- This is not avoidable that the oil of the hydraulic port may be leaked to the next air port for the long time use, due to the characteristic of the seal. Please do not assign the air port next to the hydraulic port as much as possible.
- The rotary joint must be specially treated to prevent from the rust, when using the glycol solution for the operating fluid. Please inform us when ordering.
- When the rotary joint is designed at your side, please select the low friction type seal. Then, please check the rotary table movement after installation of your rotary joint, not to over load.

Code No. of Rotary Joint

Table Model	No. of port	Type	Code No.	Remarks
CNC105R	3+1	Cylinder type	RT-CN105SD-3+1-L	3+1RJ Cylinder type
	4+1		RT-CN105SD-4+1-L	4+1RJ Cylinder type
	6+1		RT-CN105SD-6+1-L	6+1RJ Cylinder type
CNC105L	3+1		RT-CN105SD-3+1-R	3+1RJ Cylinder type
	4+1		RT-CN105SD-4+1-R	4+1RJ Cylinder type
	6+1		RT-CN105SD-6+1-R	6+1RJ Cylinder type
CNC180, 202	3+1	Cylinder type	RT-CN180SD-3+1-L	3+1RJ Cylinder type
	3+1		RT-CN180SD-3+1-R	
	4	Flange Plate type	RN-CN180SD-4+N-F	4RJ Flange Plate type
	4+1	Cylinder type	RT-CN180SD-4+1-L	4+1RJ Cylinder type
	4+1		RT-CN180SD-4+1-R	
	4+1	Flange Plate type	RN-CN180SD-4+1-F	4+1RJ Flange Plate type
	5+1	Flange Plate type	RN-CN180SD-5+1-F	5+1RJ Flange Plate type
	6	Flange Plate type	RN-CN180SD-6+N-F	6RJ Flange Plate type
	6+1	Cylinder type	RT-CN180SD-6+1-L	6+1RJ Cylinder type
6+1	RT-CN180SD-6+1-R			
CNC205	6+1	Flange Plate type	RN-CN205SD-6+1-B	6+1RJ Flange Plate type
NCT200	6	Flange Plate type	RN-NC200SD-6+N-F	6RJ Flange Plate type
	6+1	Cylinder type	RT-NC200SD-6+1-L	6+1RJ Cylinder type
	6+1		RT-NC200SD-6+1-R	
NCT200E	6	Flange Plate type	RN-NC20ESD-6+N-F	6RJ Flange Plate type
	6+1	Cylinder type	RT-NC20ESD-6+1-L	6+1RJ Cylinder type
	6+1		RT-NC20ESD-6+1-R	
CNC260, 302	4+1	Cylinder type	RT-CN260SD-4+1-L	4+1RJ Cylinder type
	4+1		RT-CN260SD-4+1-R	
	4+1	Flange Plate type	RN-CN260SD-4+1-F	4+1RJ Flange Plate type
	6+1	Cylinder type	RT-CN260SD-6+1-L	6+1RJ Cylinder type
	6+1		RT-CN260SD-6+1-R	
	6+1	Flange Plate type	RN-CN260SD-6+1-F	6+1RJ Flange Plate type
	8+1	Cylinder type	RT-CN260SD-8+1-L	8+1RJ Cylinder type
	8+1		RT-CN260SD-8+1-R	
8+1	Flange Plate type	RN-CN260SD-8+1-F	8+1RJ Flange Plate type	
CNC260P, 302P	4+1	Cylinder type	RT-CN26PSD-4+1-L	4+1RJ Cylinder type
	4+1		RT-CN26PSD-4+1-R	
	4+1	Flange Plate type	RN-CN26PSD-4+1-F	4+1RJ Flange Plate type
	6+1	Cylinder type	RT-CN26PSD-6+1-L	6+1RJ Cylinder type
	6+1		RT-CN26PSD-6+1-R	
	6+1	Flange Plate type	RN-CN26PSD-6+1-F	6+1RJ Flange Plate type
	8+1	Cylinder type	RT-CN26PSD-8+1-L	8+1RJ Cylinder type
	8+1		RT-CN26PSD-8+1-R	
	8+1	Flange Plate type	RN-CN26PSD-8+1-F	8+1RJ Flange Plate type
CNC321	8+1	Built-in type	RN-CN321SD-8+1-B	8+1RJ Flange Plate type
CNC401	8+1	Built-in type	RN-CN401SD-8+1-B	8+1RJ Flange Plate type
CNC503H	8+1	Built-in type	RN-CN503HSD-8+1-B	8+1RJ Flange Plate type
	12+1		RN-CN503HSD-12+1-B	12+1RJ Flange Plate type
CNC501	8+1	Built-in type	RN-CN501SD-8+1-B	8+1RJ Flange Plate type
CNC601	8+1	Built-in type	RN-CN601SD-8+1-B	8+1RJ Flange Plate type

O/P

How to Read Product Code of ROTARY JOINT



Code No. of Rotary Joint

Table Model	No. of port	Type	Code No.	Remarks
CST100-135	4+1	Cylinder type	RT-CST100SD-4+1-L	4+1RJ Cylinder type
	4+1		RT-CST100SD-4+1-R	
TAT-105N	3+1	Cylinder type	RT-TA105SD-3+1-L	3+1RJ Cylinder type
	3+1		RT-TA105SD-3+1-R	
	4+1		RT-TA105SD-4+1-L	4+1RJ Cylinder type
	4+1		RT-TA105SD-4+1-R	
	6+1		RT-TA105SD-6+1-L	6+1RJ Cylinder type
	6+1		RT-TA105SD-6+1-R	
TAT-170N	3+1	Cylinder type	RT-TA170SD-3+1-L	3+1RJ Cylinder type
	3+1		RT-TA170SD-3+1-R	
	4+1		RT-TA170SD-4+1-L	4+1RJ Cylinder type
	4+1		RT-TA170SD-4+1-R	
	6+1		RT-TA170SD-6+1-L	6+1RJ Cylinder type
	6+1		RT-TA170SD-6+1-R	
TAT-200N	4+1	Cylinder type	RT-TA200SD-4+1-L	4+1RJ Cylinder type
	4+1		RT-TA200SD-4+1-R	
	6+1		RT-TA200SD-6+1-L	6+1RJ Cylinder type
	6+1		RT-TA200SD-6+1-R	
	8+1		RT-TA200SD-8+1-L	8+1RJ Cylinder type
	8+1		RT-TA200SD-8+1-R	
TAT-250N	4+1	Cylinder type	RT-TA250SD-4+1-L	4+1RJ Cylinder type
	4+1		RT-TA250SD-4+1-R	
	6+1		RT-TA250SD-6+1-L	6+1RJ Cylinder type
	6+1		RT-TA250SD-6+1-R	
	8+1		RT-TA250SD-8+1-L	8+1RJ Cylinder type
	8+1		RT-TA250SD-8+1-R	
5AX-100	3	Flange Plate type	RN-AX101SD-3+N-A	3RJ Flange Plate type
	4	Cylinder type	RT-AX101SD-4+N-A	4RJ Cylinder type
5AX-130	3	Cylinder type	RT-AX130SD-3+N-A	3RJ Cylinder type
	4		RT-AX130SD-4+N-A	4RJ Cylinder type
5AX-201	4	Flange Plate type	RN-AX201SD-4+N-A	4RJ Flange Plate type
	6+1	Cylinder type	RT-AX201SD-6+1-A	6+1RJ Cylinder type
5AX-250	3	Flange Plate type	RN-AX250SD-3+N-A	3RJ Flange Plate type
5AX-350	6	Flange Plate type	RN-AX350SD-6+N-A	6RJ Flange Plate type
5AX-550	6	Flange Plate type	RN-AX550SD-6+N-A	6RJ Flange Plate type

RT - CN105 SD - 3+1 - L

Hose Direction of the Sleeve seen from behind, or sub-code.

- R : Right (Cylinder type) Fig.1
- L : Left (Cylinder type) Fig.2
- F : Flange (Flange Plate type) Fig.3
- B : Main Unit (Built-in type)
- A : 5AX

Number of Ports
3+1 With a Center Port
3+N W/O a Center Port

SD : Standard

Diameter of Table

RT : Cylinder type Rotary Joint

RN : Flange Plate type Rotary Joint, Built-in type Rotary Joint.

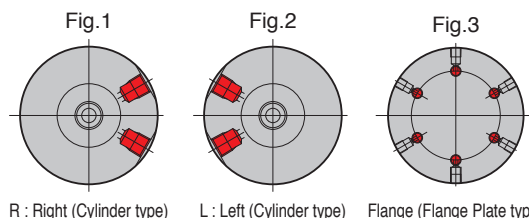

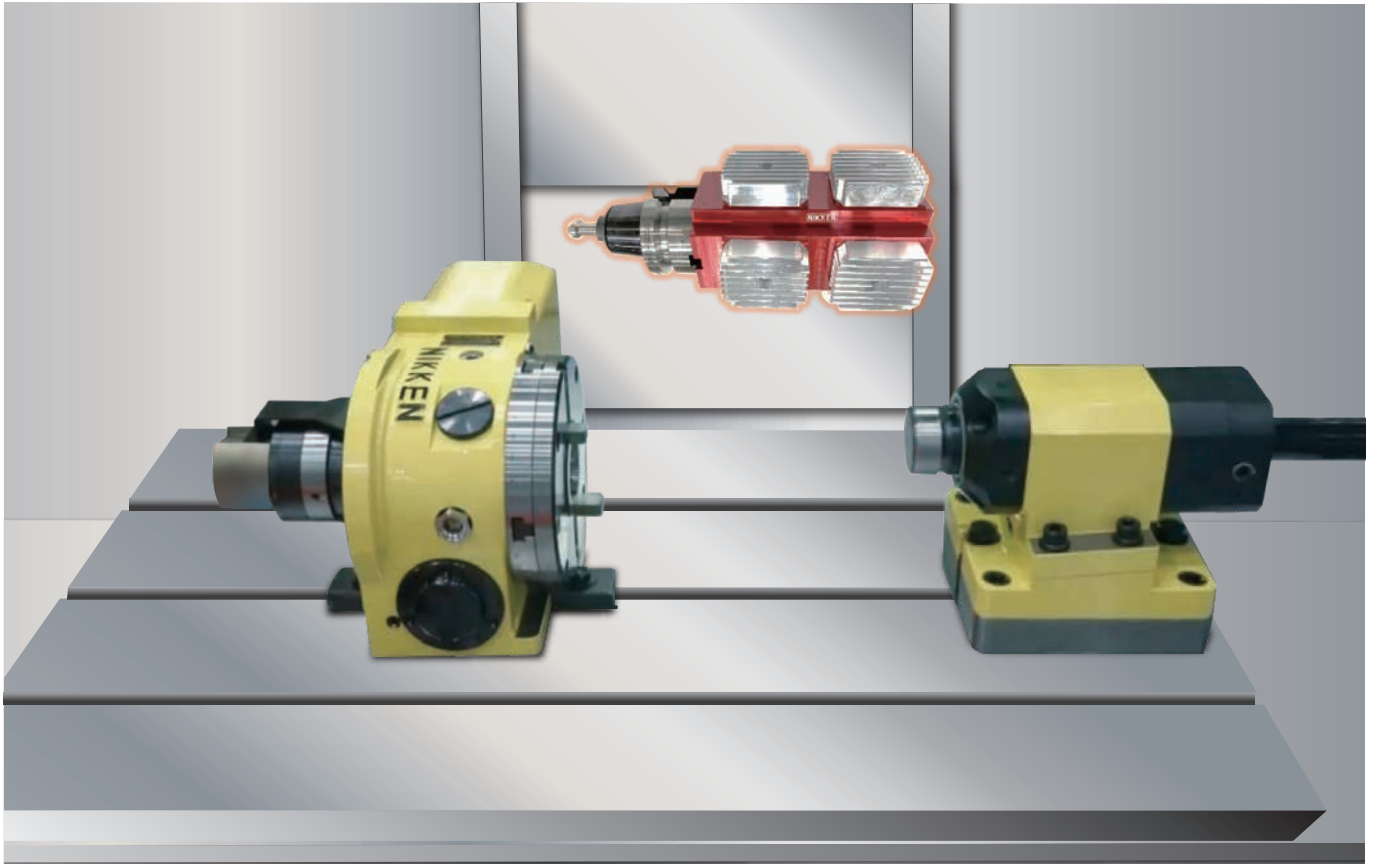

■ When pulling

This holder adopts a 12° short taper that achieves high static rigidity due to its gentle taper angle. Its feature is that it can achieve higher tightness by combining a taper cone with a slit that aligns the center and contracts when pulling in.

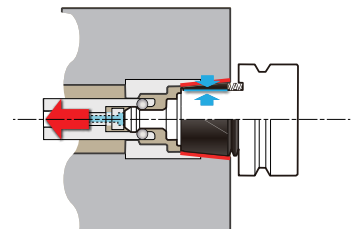

■ When clamping

The holder is further retracted, the internal disc spring contracts in sync with the taper cone's contraction, causing the flange face to tightly adhere. As a result, the two face of the taper and flange provides high rigidity.

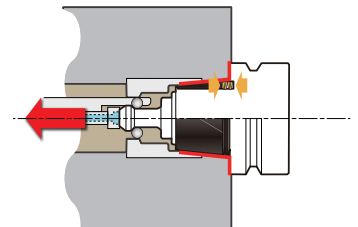

■ When unclamping

During unclamping, air is sprayed to clean the taper and flange sections.

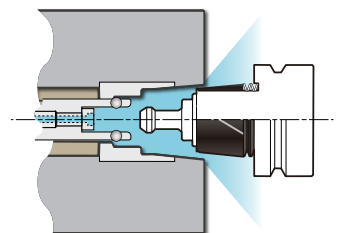

Multi Jig Fixture Holder System



The shank of the Multi Jig Fixture Holder is available in RN40 and RN45 types.

RN40	CNC105,5AX-130
RN45	CNC180,202,260P,5AX-201

Multi Jig Fixture Holder with flange mount

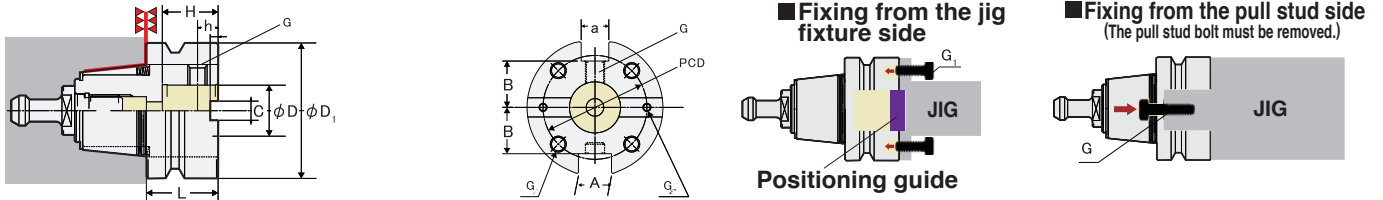

Code No.	L	D	D1	H	h	A ^{+0.2}	a ^{±0.005}	B	C	PC	G	G ₁	G ₂	Mounting weight	Weight
RN40-63-25-P	40	25	63	30	15	18	16	22.5	10	48	M10×25L	M 8×15L	M4× 8L	8k g (estimate)	1.5kg
RN45-85-32-PS	45	32	85	35	20	20	18	29	12	65	M10×25L	M10×15L	M5×10L	10k g (estimate)	2.5kg

Multi Jig Fixture Holder with milling chuck

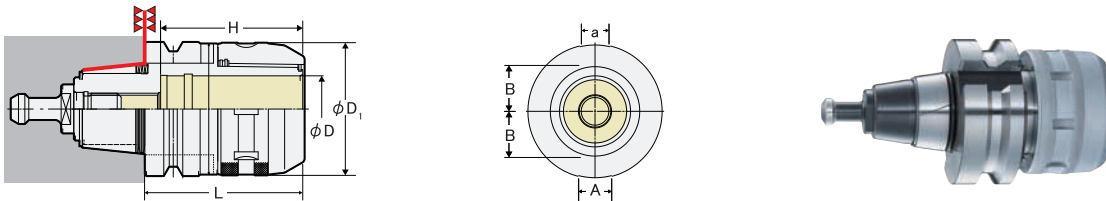

Code No.	L	D	D ₁	H	A ^{+0.2}	a ^{±0.005}	B	Weight
RN40-C32-90-PS3	90	32	69	77	18	16	22.5	2.5kg
RN45-C32-100-PS	100	32	69	85	20	18	29	3.8kg
RN45-C42-100-PS	100	42	84	90	20	18	29	4.5kg

Multi Jig Fixture Holder with Scroll chuck

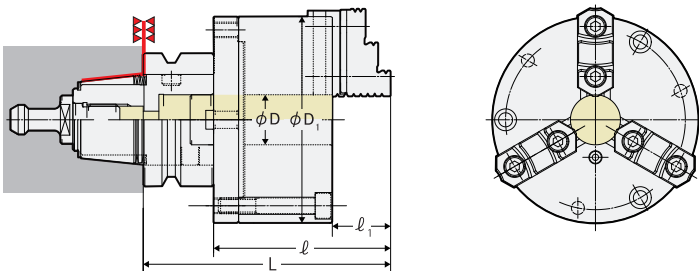

Code No.	L	l	l ₁	D	D ₁	Chuck size	Gripping range*		Weight
							Outer dia.	Inner dia.	
RN40-SC4-PS332	141.3	101.3	31.2	24	112	4 $\frac{1}{2}$ "	2~ 89	36~78	6kg
RN45-SC5-PS3	158.3	113.3	37.2	32	132	5 $\frac{1}{2}$ "	3~104	42~92	9.5kg

*This is within a range that can be accurately grasped. This is not the stroke of the jaws.

Multi Jig Fixture Holder sample

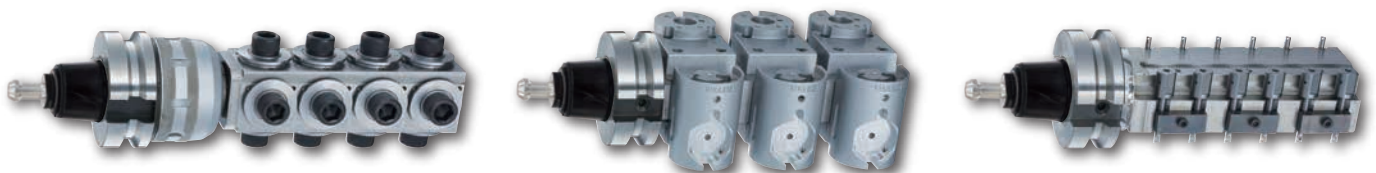

Multi Jig Fixture Holder System



Multiple workpieces can be set on the Multi Jig Fixture Holder, during machining.

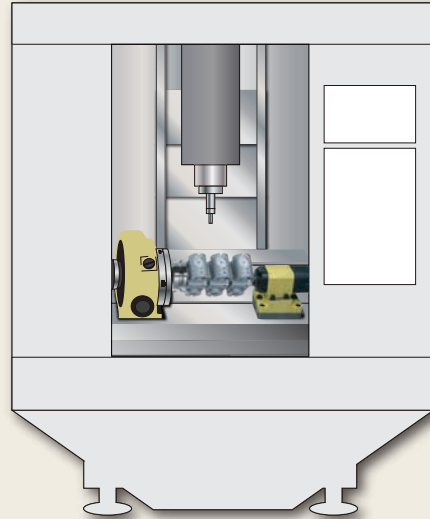
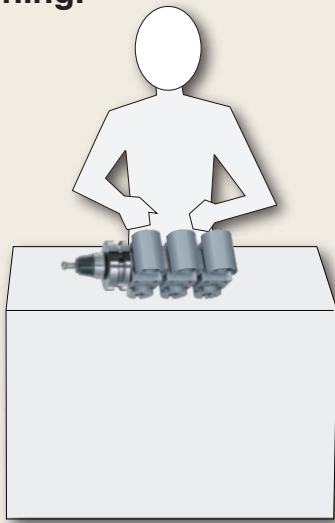

Multiple workpieces can be machined continuously, enabling unmanned operation for extended periods.

Simple ①

The holder has very accurate repeatability, which eliminates the need for centering skills or experience.

Simple ②

If multiple workpieces can be set on the holder, high efficiency continuous machining can be easily achieved through external setup.

Simple ③

When accommodating different workpieces, simply changing the tip jig fixture of the holder enables easy machining of low volume production of high varieties.

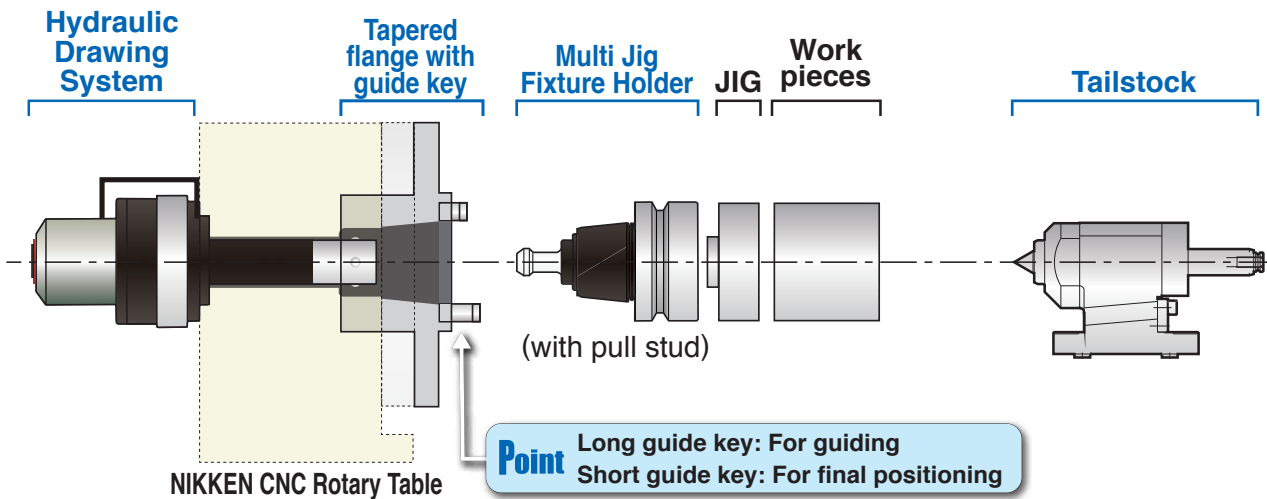

CNC rotary table	Hydraulic Drawing System (Drawing force of 7.9kN at 3.5MPa)	Tapered flange with guide key	Multi Jig Fixture Holder with flange mount	(Option) Tailstock*1
CNC105	HYD-PD-CN105	TF40-GKYE-CN105	RN40-63-25-PS332	PBA-105 (Air/Hyd)*2
CNC180	HYD-PD-CN180	TF45-GKYE-CN180	RN45-85-32-PS3	PBA-135 (Air/Hyd)*2
CNC202	HYD-PD-CN180	TF45-GKYE-CN180	RN45-85-32-PS3	PBA-135 (Air/Hyd)*2
CNC260P	HYD-PD-CN26P	TF45-GKYE-CN26P	RN45-85-32-PS3	PBA-170 (Air/Hyd)*2, H-170S (Hyd)
5AX-130H	HYD-PD-AX130	TF40-GKYE-AX130	RN40-63-25-PS332	-
5AX-201H	HYD-PD-AX201	TF45-GKYE-AX201	RN45-85-32-PS3	-

* 1: The stroke of all tailstocks is 100 mm. Max. workpiece dia. for the H-170S is ϕ 130mm.

* 2: For the PBA series, select either pneumatic or hydraulic for your application. Please contact us for the tailstock control.

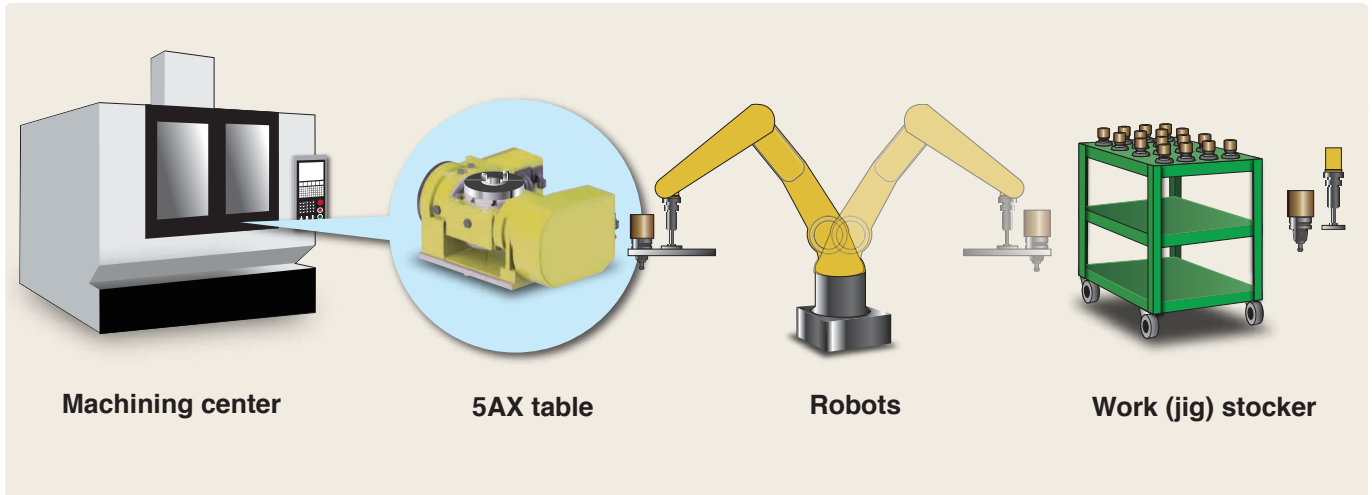

Machining center

5AX table

Robots

Work (jig) stocker

■ All faces can be machined using the 5AX table.



▶ P.90

All faces can be machined with one operation. Consolidate processes and improve machining accuracy.

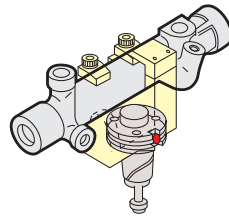

■ Tool wagon for stocker



Using a tooling wagon for the stocker makes it easy to make the stocker, and move it to the next process.

Positioning of the holder



Location of the Tool wagon



Install a stopper block for location the tool wagon.

Without Multi Jig Fixture Holder	With Multi Jig Fixture Holder
<p>Various kinds of robot arms are required depending on the jig or workpiece.</p>	<p>One type of robot arm can be used for all applications.</p>

When automation with robots, various arms are required to match the jigs and the workpieces.

In addition, Stocker design and robot teaching require significant costs and time.

With the multi jig fixture holder system, a single type of robot arm can be used to grip the V-flange portion of the holder. This greatly reduces the hurdles to introducing robots in the future.

Multi Jig Fixture Holder System



Additional axis specifications

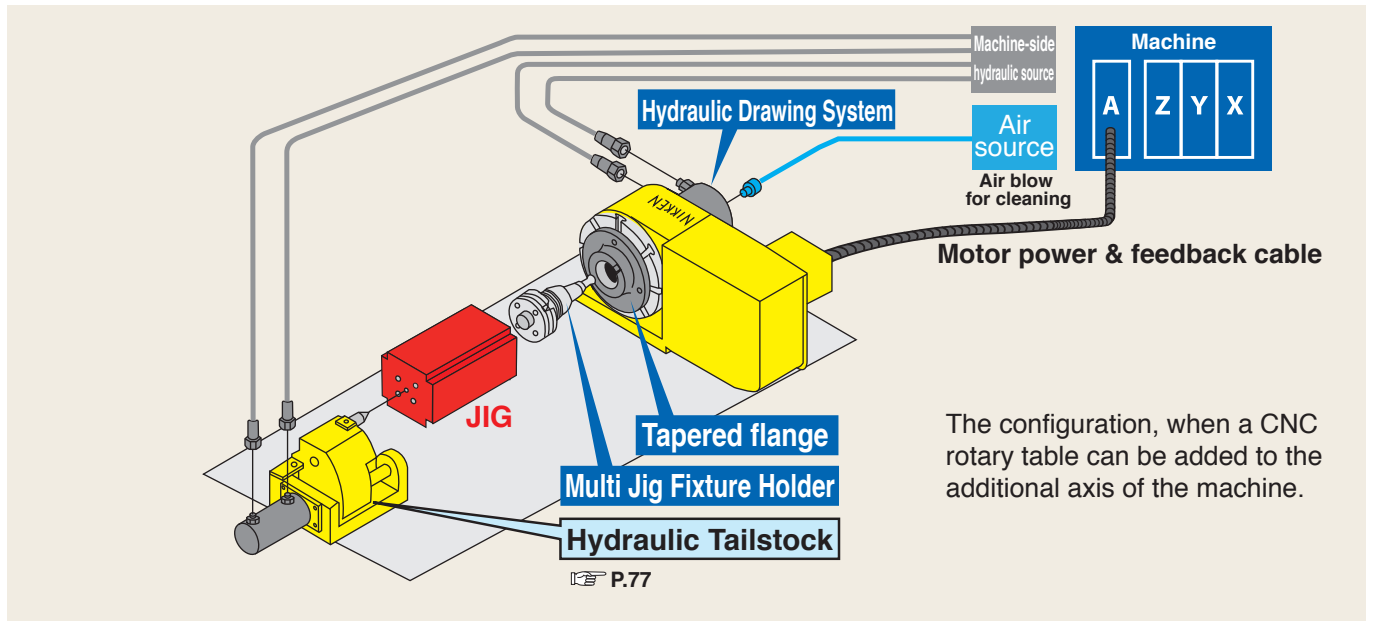

★Please contact us if a hydraulic source cannot be obtained from the machine side.

M signal specification

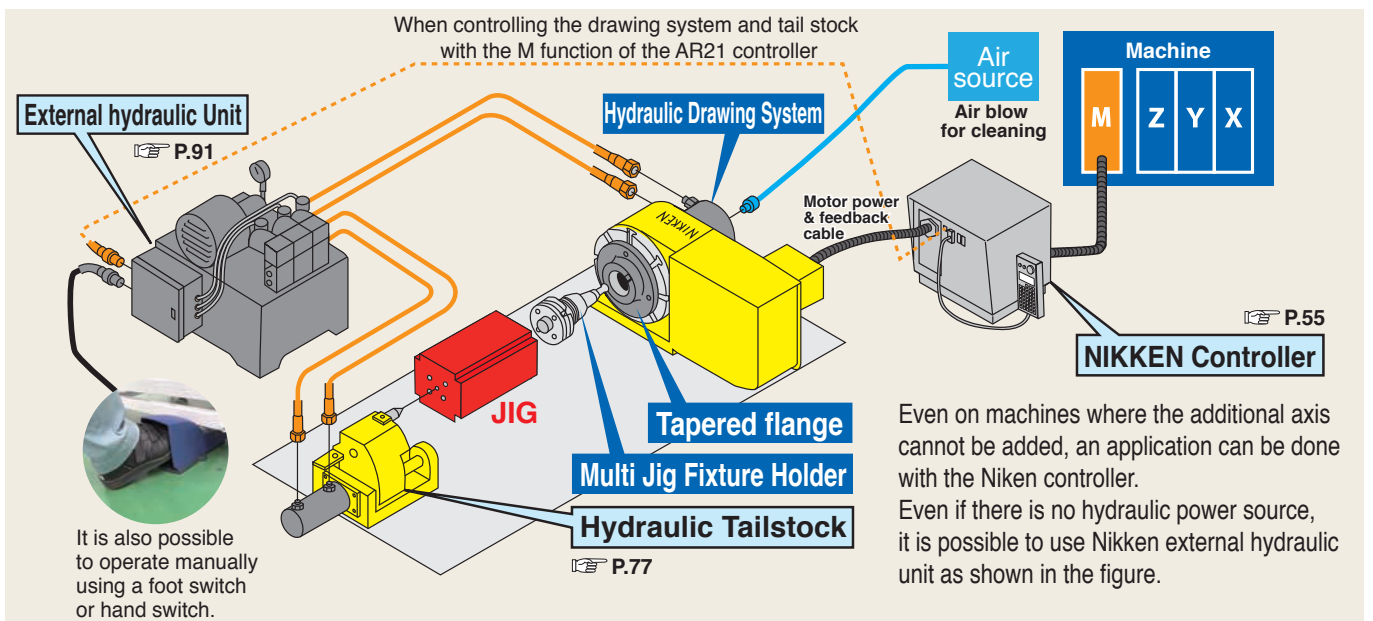

★Please contact us for the tailstock control.

O/P

First, try to change manually on the CNC rotary table.

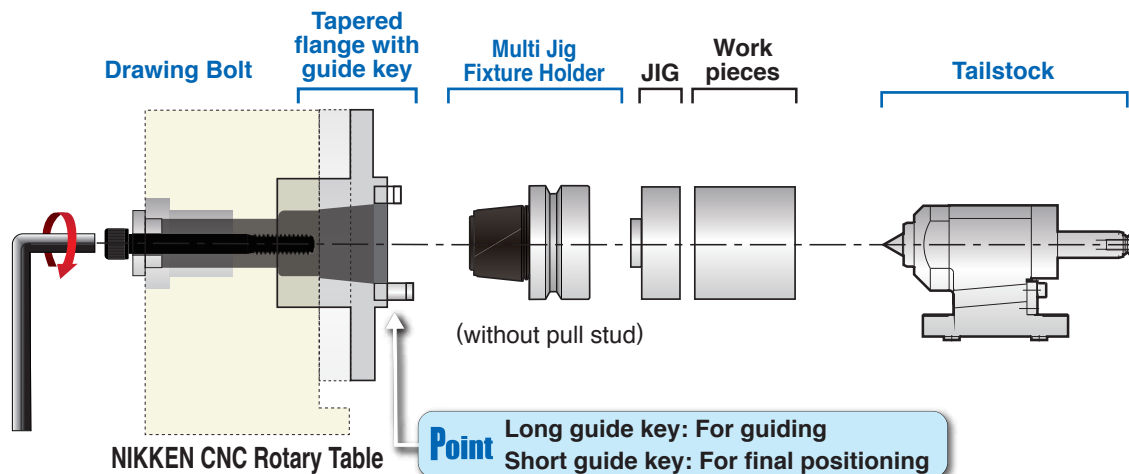

CNC rotary table	Drawing Bolt (with collar)	Tapered flange with guide key	Multi Jig Fixture Holder	Tailstock
CNC105	PBS-CN105	TF40-GKYE-CN105	RN40-63-25	PBA-105
CNC180	PBS-CN180	TF45-GKYE-CN180	RN45-85-32	PBA-135
CNC202	PBS-CN180	TF45-GKYE-CN180	RN45-85-32	PBA-105
CNC260P	PBS-CN26P	TF45-GKYE-CN26P	RN45-85-32	PBA-170

The Multi Jig Fixture Holder can also be used for 5 faces machining of the workpieces.

System with 5AX-Table

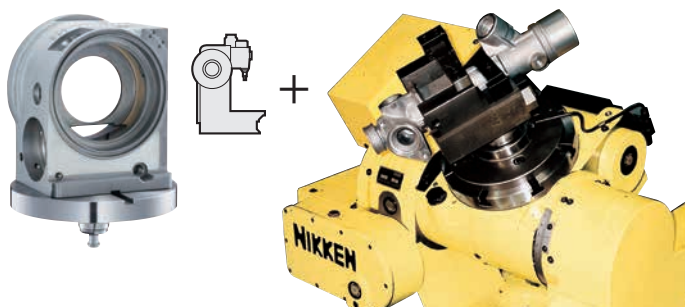

The full surface machining on top half of the component can be achieved with only one setup. The machining cycle time will be adjusted with increasing the number of machines.

- As the full surface machining can be done with only one setup, the finish quality will be improved.
- Even if one machine breaks down, the extended operation time on another machine can achieve same quantity of production.
- It's easy and quick to machine new design component only by changing machining program.
- The random production can be done by the jig holder with ID tip. (That's ideal for the automotive production line as there are many pair parts of right and left.)

Samples

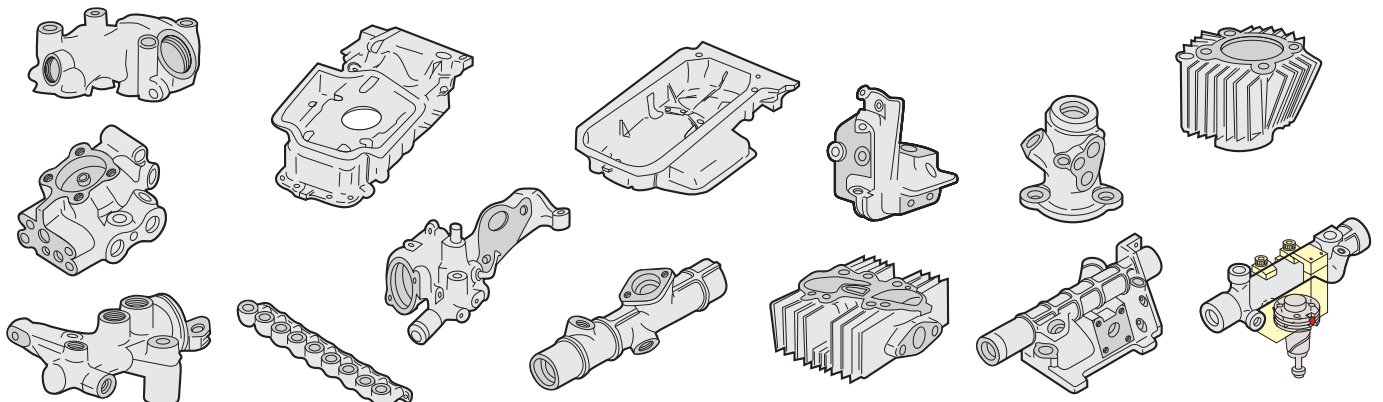

Waterproof Specifications

- Mechanical parts of the table are perfectly sealed. For water resistance to electric parts such as cables, the hard-wired type connection on the motor cover is available as an option.
- For the rotary table with pneumatic clamping, air purge is arranged inside the motor cover as standard.
- In case of the table which with AR21 controller, the hard-wired type connection on the rotary table side and harting connector fitting on the controller side, however, the harting connector fitting on the rotary table side is also available as an option.
- For AR21 PW controller, water resistant connector type cables are supplied as standard.

For all CNC rotary tables, ▲ mark obtained parts or equivalent and Ⓢ marked electric parts are used, ensuring high safety.
 ▲ : Safety approval mark by TÜV RHEINLAND.
 Ⓢ : Safety mark required for marketing in Europe from '95.



Cable Direct Out type



Cable with Blade (Option)
Standard Length: 5m



Harting Connector type

Position & Direction of Connecting Cable

The standard of the cable connecting direction is **B** or **D**. **A** or **C** is possible on demand.

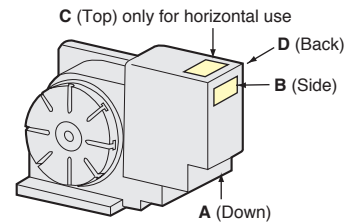

Hydraulic Unit

Specifications

TCC-150

MAX.14ℓ/min

MAX.3.5MPa

- AC 200~220V, 3 phases, Capacity : 1KVA.
- Solenoid valves and pressure switches depends on your applications.
- Dimension : 400×405×479mm

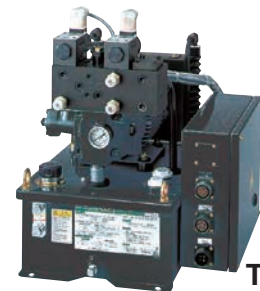

TCC-150

Air Intensifying Booster (Max. Output: 0.7MPa)

The air pressure can be double by Air Intensifying Booster. This is suitable for tables with the Double Intensifying Clamping System.

Air Hydraulic Booster

Please order an air hydraulic unit for the machine without hydraulic source.

Applicable for **CNC260, CNC302 : AY0400 / CNC321~CNC803 : NB-AB30-150 / 5AX-201,350 : NB-AB30-75**

Please ask for the layout of the booster.

VBA10A-02G

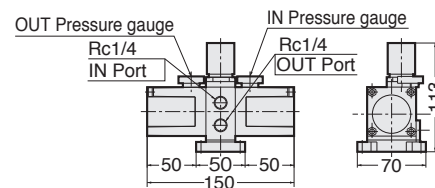

AY0400

Oil Capacity: 30cc
 Input pneumatic Pressure: 0.4~0.5MPa
 Output hydraulic Pressure: 2.0~2.5MPa

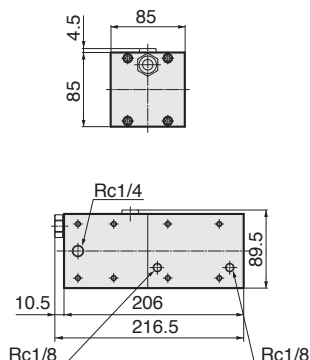

NB-AB30-150

Oil Capacity: 150cc
 Input pneumatic Pressure: 0.41~0.47MPa
 Output hydraulic Pressure: 3.5~4.0MPa

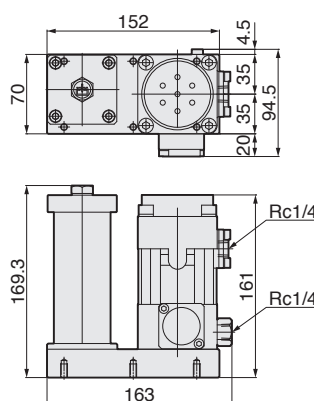

NB-AB30-75

Oil Capacity: 75cc
 Input pneumatic Pressure: 0.41~0.47MPa
 Output hydraulic Pressure: 3.5~4.0MPa

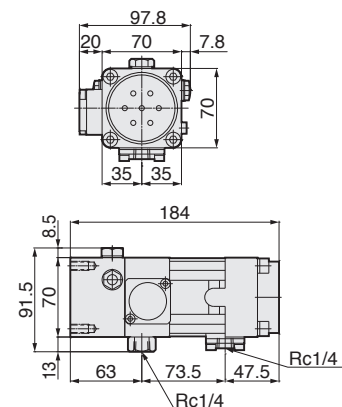

Air Craft-related Parts Apprication.

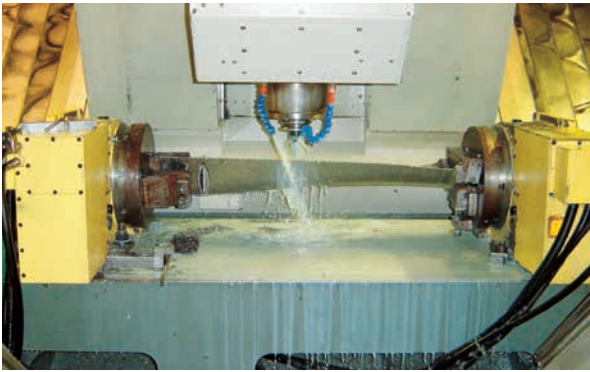

Synchronous Rotation by CNC401 X 2units

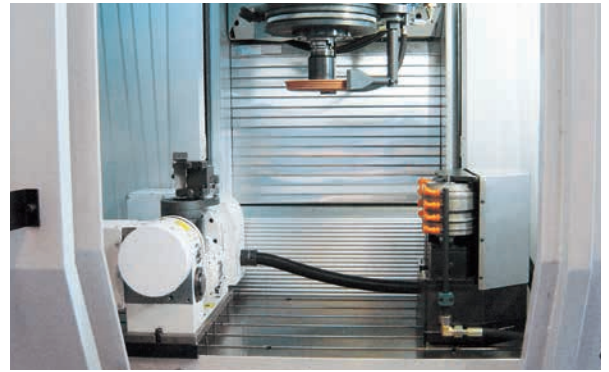

5AX-150 for 4th and 5th axes tilting rotary table on special grinding center

Automobile Parts Apprication.



CNC180 + TAT-105N



CNC601, 3m Jig Block & TAT-501N

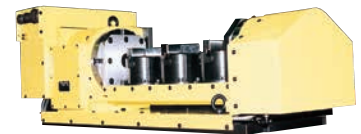

3 sets of power chucks are used for work clamping.

Energy-related Parts Apprication.



Support Branch

CNC1800 & Support Branch
Indexing/ clamping of the turbine disk

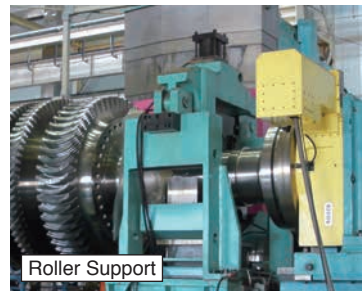

Roller Support

CNC1201 Indexing of the turbine shaft. Turbine shaft is supported and clamped by the roller support.

Built-in Pallet Clamp System

Available to CNC rotary table and 5AX- tilting rotary table. Very suitable to NC special purpose machine and Horizontal M/C as built-in B axis table.

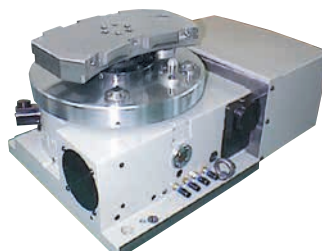
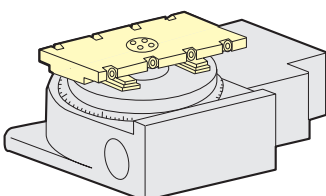

Lifting type Pallet Clamp Unit

Special Color

Please order with the color sample or Munsell Color No.

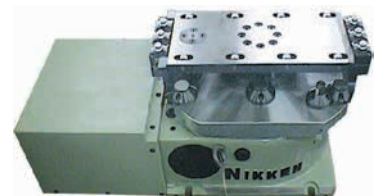

Pallet Clamp Unit with Automatic Coupler

Special Specification 3



NIKKEN CNC rotary tables are used in various kinds of world wide applications. Please contact with us with the dimension of your work piece and construction of the jig fixture etc. We will recommend you the best application.

Combination with Pallet Changer

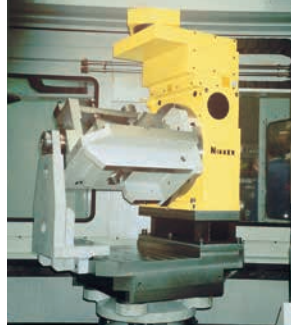

2 units of CNC rotary tables are used on the TAPPING CENTER with swing type pallet changer.

Combination of CNC Rotary Tables

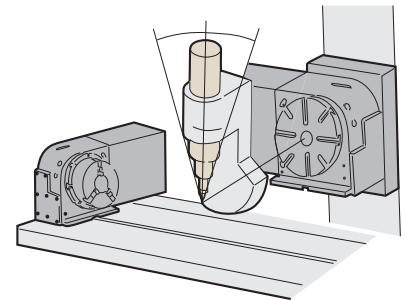
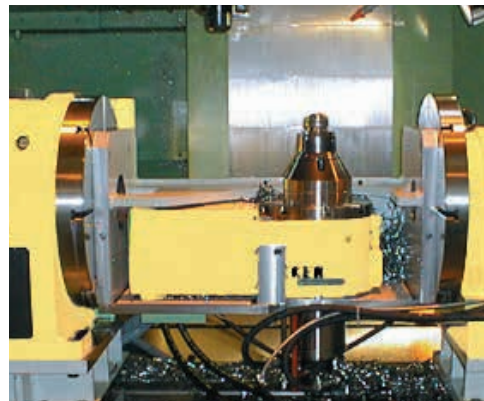

Machining of turbine wheel to use 2 units of CNC rotary tables, one for the swing axis of the HF motor and the other for the rotary axis of the work piece



5AX-400FA-RJ8-800/150

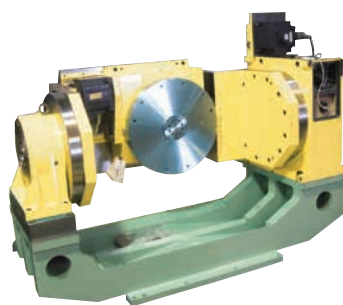

5AX-500MA-RJ10-900/100

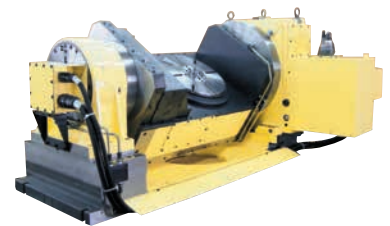

5AX-321FA



CNC180+TAT-105N+CNCZ503

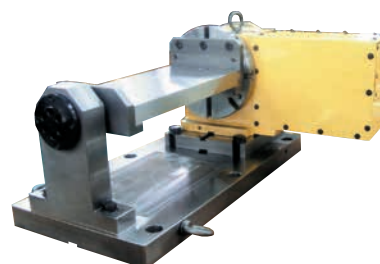

CNC180+Special Support Table

O/P

Special Specification 4



Example of 5AX Rotary Table location on M/C

There are various ways of arrangement.

- ▼ Tail Stock is used together.
- ▼ Y axis stroke of the M/C is not enough
- ▼ Y axis stroke is enough
- ▼ Tilting range is 30-135

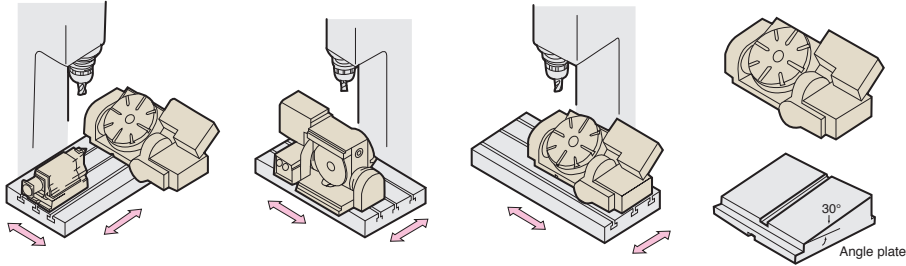

5AX-300

Example on the angle base (60°)

Application of 5AX-Table



5AX-500 with square table

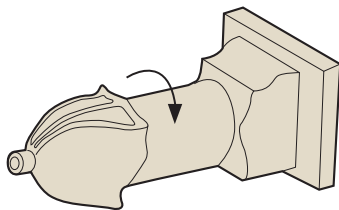

Simultaneous 3 axes control of X, Z & A axis instead of turning.

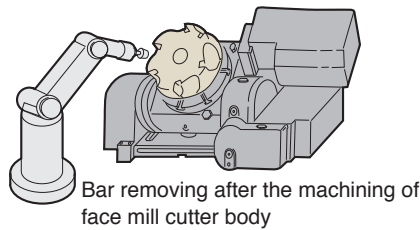

Bar removing after the machining of face mill cutter body

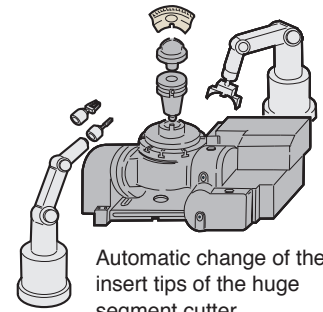

Automatic change of the insert tips of the huge segment cutter

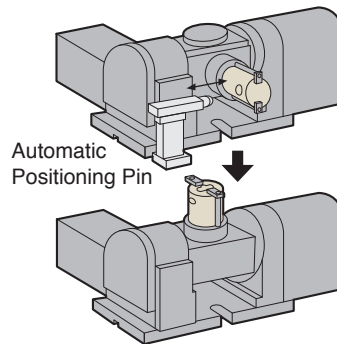

Automatic Positioning Pin

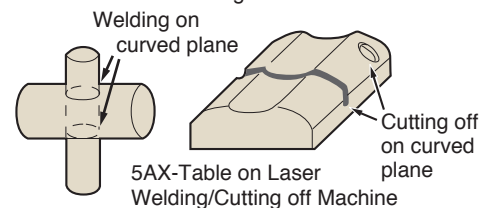

Welding on curved plane

5AX-Table on Laser Welding/Cutting off Machine

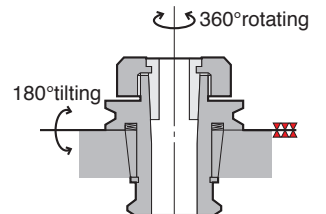

5AX-Multi Spindle Table + Jig Holder with Through Hole

1. The work piece is exchanged by ROBOT, the positioning pin goes forward, then the work piece is clamped at the tilting axis = 90°.
2. The positioning pin goes backward, the tilting axis moves to 0°, then the machining starts.

The tilting movement is used only for automatic work piece exchange

Other Application

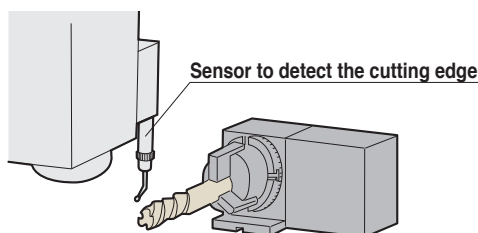

Sensor to detect the cutting edge

Work piece (Cutter) is exchanged by ROBOT, and the cutting edge will be detected automatically.

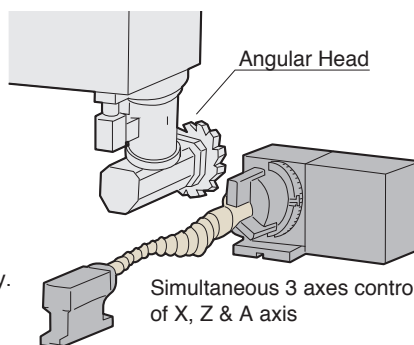

Angular Head

Simultaneous 3 axes control of X, Z & A axis

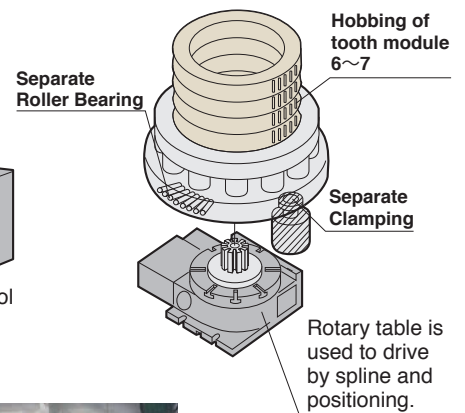

Hobbing of tooth module 6~7

Separate Roller Bearing

Separate Clamping

Rotary table is used to drive by spline and positioning.

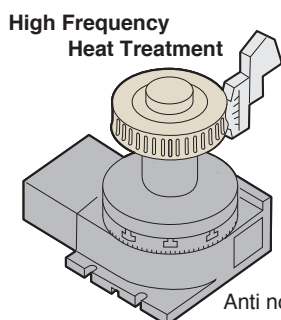

High Frequency Heat Treatment

Anti noise process is required.

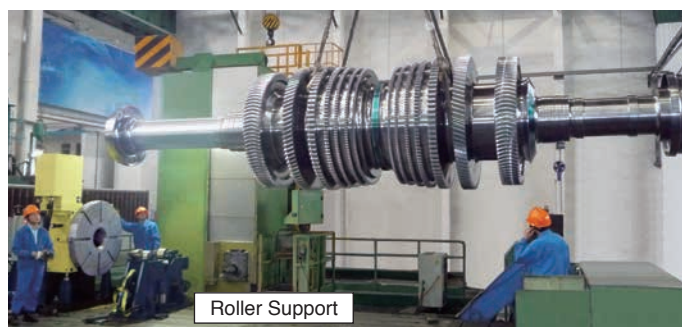

Roller Support

CNC1201 Indexing of the turbine shaft. Turbine shaft is supported and clamped by the roller support.

■ CNC Rotary Table only for Vertical Use...Back side motor mounted type ☞ P.21,22, Top side motor mounted type ☞ P.17~P.20

No.	Measuring Item	Measuring Method	CNC180*202 NCT200	CNC205	CNC260, 260P 302, 302P	CNC321 401	CNCB350 450	CNC501 601
2	Runout of table surface		0.01mm	0.01mm	0.015mm	0.015mm	0.015mm	0.02mm
3	Concentricity of center bore		0.01mm	0.01mm	0.01mm	0.01mm	0.01mm	0.01mm
4	Squareness of table surface (Minus deviation at upper part is not permitted.)		0.02mm	0.02mm	0.02mm	0.02mm	0.02mm	0.03mm
5	Parallelism between center line of test bar and key way		At 150mm 0.02mm	0.02mm	0.02mm	0.02mm	0.02mm	0.02mm
6	Parallelism between frame bottom surface and table center line		At 150mm 0.02mm	0.02mm	0.02mm	0.02mm	0.02mm	0.03mm
7	Indexing accuracy		±20"	±20"	20"	15"	15"	15"
8	Repeatability		4"	4"	4"	4"	4"	4"

★ For ultra precision option: One rank higher accuracies than the above figures are inspected.

★ Please contact us for the accuracy of the rotary table larger equal to **CNC802** for vertical use.

■ CNC Rotary Table only for Horizontal Use...Built-in type ☞ P.55

No.	Measuring Item	Measuring Method	CNC180 202 NCT200	CNC260, 260P 302, 302P	CNC321 401 400H	CNC503H 501 601	CNC802 1000	CNC1200 1201	CNC1600
1	Parallelism between table surface and frame bottom surface (Concave)		0.015mm	0.02mm	0.02mm	0.02mm	0.03mm	0.04mm	0.05mm
2	Runout of table surface at horizontal position		0.01mm	0.015mm	0.015mm	0.015mm	0.03mm	0.03mm	0.04mm
3	Concentricity of center bore		0.01mm	0.01mm	0.01mm	0.01mm	0.01mm	0.01mm*1	0.01mm*1
6	Squareness between frame bottom surface and table center line		At 150mm 0.02mm	0.02mm	0.02mm	0.03mm	—	—	—
7	Indexing accuracy		±20"	20"	15"	15"	15"	15"	15"
8	Repeatability		4"	4"	4"	4"	4"	4"	4"

★ For ultra precision option: One rank higher accuracies than the above figures are inspected.

★ Center socket is provided at the center bore for the table marked *1. Concentricity of the internal center socket is shown.

■ DD Motor ... ☞ P.49~P.54

No.	Measuring Item	Measuring Method	DD201F-60	DD251F-150	DD402F-300	No.	Measuring Item	Measuring Method	5AX-DD100AF	5AX-DD201AF3	5AX-DD201BF3
2	Runout of table surface		0.01mm	0.01mm	0.015mm	1	Parallelism between table surface and frame bottom at tilting angle 0° (Concave)		0.01mm	0.01mm	0.01mm
3	Concentricity of center bore		0.01mm	0.01mm	0.01mm	2	Deviation of table surface at tilting angle 0°		0.01mm	0.01mm	0.01mm
4	Squareness of table surface (Minus deviation at upper part is not permitted.)		0.01mm	0.01mm	0.02mm	3	Deviation of table center hole at tilting angle 0°		0.01mm	0.01mm	0.01mm
5	Parallelism between frame bottom surface and table center line		At 150mm 0.02mm	0.02mm	0.02mm	4	Displacement of center when moving from 0° to 90° at tilting angle 90°		0.015mm	0.015mm	0.015mm
6	Parallelism between frame bottom surface and table center line		At 150mm 0.02mm	0.02mm	0.02mm	5	Parallelism between table surface and center line of guide key at tilting angle 90°		0.01mm	0.01mm	0.01mm
7	Indexing accuracy		±10"	±10"	±10"	6	Indexing accuracy of rotary axis		±5"	±10"	±10"
8	Repeatability		4"	4"	4"	7	Repeatability of rotary axis		2"	4"	4"
						8	Repeatability of tilting axis		±10"	±15"	±15"
						9	Indexing accuracy of tilting axis		±3"	6"	6"

■ CNC Rotary Table for both of Vertical and Horizontal Use

No.	Measuring Item	Measuring Method	CNC105	CNC180·202 NCT200	CNC260, 260P 302, 302P	CNC321 401	CNCB350 450	CNC501 601	CNC 803 1003
1	Parallelism between table surface and frame bottom surface (Concave)		0.015mm	0.015mm	0.02mm	0.02mm	0.02mm	0.02mm	0.03mm
2	Runout of table surface		0.01mm	0.01mm	0.015mm	0.015mm	0.015mm	0.02mm	0.03mm
3	Concentricity of center bore		0.01mm	0.01mm	0.01mm	0.01mm	0.01mm	0.01mm	0.01mm
4	Squareness of table surface (Minus deviation at upper part is not permitted.)		0.02mm	0.02mm	0.02mm	0.02mm	0.02mm	0.03mm	0.04mm
5	Parallelism between center line of test bar and key way		At 150mm 0.02mm	0.02mm	0.02mm	0.02mm	0.02mm	0.02mm	0.02mm
6	Parallelism between frame bottom surface and table center line		At 150mm 0.02mm	0.02mm	0.02mm	0.02mm	0.02mm	0.03mm	0.03mm
7	Indexing accuracy		±30"	±20"	20"	15"	15"	15"	15"
8	Repeatability		4"	4"	4"	4"	4"	4"	4"

★ For ultra precision option: One rank higher accuracies than the above figures are inspected.

★ Please contact us for the accuracy of the rotary table larger equal to **CNC802** for both of vertical and horizontal use.

■ NST, 5AX- Tilting Rotary Table

No.	Measuring Item	Measuring Method	NST ²⁵⁰ ₃₀₀	NST500	5AX ¹⁰⁰ ₁₃₀	5AX-201	5AX-250	5AX-230 350	5AX-500	5AX-800	5AX-1200
1	Parallelism between table surface and frame bottom at tilting angle 0° (Concave)		0.02mm	0.02mm	0.015mm	0.015mm	0.02mm	0.02mm	0.03mm	0.04mm	0.05mm
2	Deviation of table surface at tilting angle 0°		0.02mm	0.02mm	0.01mm	0.01mm	0.02mm	0.02mm	0.02mm	0.03mm	0.04mm
3	Deviation of table center hole at tilting angle 0°		0.01mm	0.01mm	0.01mm	0.01mm	0.01mm	0.01mm	0.01mm	0.01mm	0.01mm ^{*1}
4	Deviation of center line of rotary axis at tilting angle 90°		0.02mm	0.02mm	0.02mm	0.02mm	0.02mm	0.02mm	0.03mm	0.04mm	0.05mm
5	Parallelism between table surface and center line of guide key at tilting angle 90°		0.02mm	0.02mm	0.015mm	0.015mm	0.02mm	0.02mm	—	—	—
6	Displacement of center when moving from 0° to 90° at tilting angle 90°		0.02mm	0.02mm	0.01mm	0.015mm	0.015mm	0.015mm	—	—	—
7	Indexing accuracy of rotary axis		20"	20"	±30"	±15"	20"	20"	20"	20"	20"
8	Repeatability of rotary axis		4"	4"	4"	4"	4"	4"	4"	4"	4"
9	Indexing accuracy of tilting axis	Cumulative	60"	60"	60"	60"	60"	60"	60"	60"	60"
10	Repeatability of tilting axis	—	—	—	±6"	±6"	±6"	±6"	±6"	±6"	±6"

★ For ultra precision option: One rank higher accuracies than the above figures are inspected.

★ Center socket is provided at the center bore for the table marked *1. Concentricity of the internal center socket is shown.

■ Mult-Spindle CNC Rotary Table ... P.25







No.	Measuring Item	Measuring Method	Accuracy
1	Pitch between Spindles		Within ±0.02mm from nominal pitch
2	Center Height of Spindle		Within ±0.02mm

■ Mult-Spindle Tilting Rotary Table ... P.47

No.	Measuring Item	Measuring Method	Accuracy
1	Pitch between Spindles		Within ±0.02mm from nominal pitch
2	Center Height of Spindle		Within ±0.02mm

★How to mount the above tables on your M/C, please contact us.

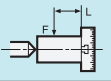
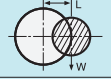
Specification

Item / Code No.		CNC260 CNCZ260	
Diameter of Table	φmm	260	
Diameter of Spindle Hole	φmm	φ80H7	
Centre Height	mm	170	
Width of T Slot	mm	12 ^{+0.018} ₀	
Clamping System	Air 0.5MPa Hyd. 3.5MPa	Air / Hyd.	
Clamping Torque	N·m	588 / 1568	
Table Inertia at motor Shaft	($\frac{GD^2}{4}$) kg·m ² ×10 ⁻³	0.33	
Servo Motor	r/min	αiF4·3000	
MIN. Increment		0.001°	
Rotation Speed	r/min	16.6(33.3)	
Total Reduction Ratio		1/120(1/60)	
Indexing Accuracy	sec	20	
Net Weight	kg	115	
MAX. Work Load on the Table	Vertical 	kg	175
	Horizontal 	kg	350
MAX. Thrust Load applicable on the Table		N	42480
		FXL N·m	1442
		FXL N·m	2320
Guide Line of MAX. Unbalancing Load		N·m	50
MAX. Work Inertia	Vertical  + ($\frac{GD^2}{4}$) kg·m ²		3.2(1.6)
Driving Torque		N·m	192(153)

Code No.

CNC:Standard

CNCZ:High Speed Z Series

The worm wheels and worm screws on **CNC** and **CNCZ** models are different and not interchangeable.

Table Diameter

Please make sure that the work inertia should be within the specified tolerance when the fixture or the work piece is larger than the rotary table diameter.

Through Hole Diameter

All model have MAX. through hole.

Clamping System

For the changing from the hydraulic brake system to the air brake system, please refer to 6-5) Supplying pneumatic or hydraulic pressure for brake and venting air.

The values are according to pneumatic 0.5 MPa / hydraulic 3.5 MPa

Servo Motor

Nikken determine the MAX. table rotation speed with the best motor rotation from the motor acceleration characteristics and the practical load test. Normally, we select the motor rotation speed of 1,500r/min or 2,000r/min. It is possible to increase the rotary table rotation speed to increase the motor rotation speed dependant of each application. Please contact with us for the details.

FANUC αi series motor can be rotated faster speed than the recommended speed.

αiF1 , αiF4 : 3,000r/min αiF12 : 2,000r/min

MAX. Work Load

The figure becomes double when the rotary table is used with tail stock or support table.

MAX. Applicable Thrust Load

This is a applicable figure for the (dynamic) cutting thrust force with cutting tools, e.g. drill, at the rotary table horizontal use.

Worm Wheel Strength

This is the strength of the worm wheel without brake. It is applied against dynamic cutting thrust.

The figure shows the strength of the bearings on the rotary table spindle and the applicable (dynamic) cutting thrust with center support.

MAX. Unbalancing Load

The guide line of MAX unbalancing load means the unbalancing load, which the rotary table is used with support table in vertical application. The guide line figure will be different according to the servo motor, please refer to P.57 for more detail.

Driving Torque

This figure shows the rotation torque at the MAX. rotation speed after acceleration.

SI Unit & Gravity Unit

SI is the abbreviation of "Systeme International d'Unites".

Item	SI Unit	Gravity Unit	Conversion
Clamping torque	N·m	kgf·m	1kgf·m=9.8N·m
Table Inertia at Motor Shaft *	($\frac{GD^2}{4}$)kg·m ² ×10 ⁻³	kg cm sec ²	1kg cm sec ² =10.2×($\frac{GD^2}{4}$)kg·m ²
MAX. Motor Rotation Speed	r/min	rpm	1rpm=1r/min
MAX. Table Rotation Speed			
MAX. Thrust Load applicable on the Table	N	kgf	1kgf=9.8N
	N·m	kgf·m	1kgf·m=9.8N·m
MAX. Work Inertia *	($\frac{GD^2}{4}$)kg·m ²	kg cm sec ²	1kg cm sec ² =10.2×($\frac{GD^2}{4}$)kg·m ²
Driving Torque	N·m	kgf·m	1kgf·m=9.8N·m
Air/Hydraulic Pressure	MPa	kgf/cm ²	1kgf/cm ² =0.098MPa

* The unit of inertia is expressed in GD².

Recommended lubricating Oil and Quantity



Recommended oil

Oil Maker	Code No.
Idemitsu Kosan	Super Multi Oil 100
JX Nippon Oil & Energy	SUPER MULPUS DX 100
Cosmo Oil Lubricants	Cosmo New Mighty Super 100

Oil Maker	Code No.
Showa Shell Sekiyu	Shell Morlina S2 BA100
EMG Marketing	Mobil DTE Heavy

Required oil quantity for CNC rotary table

Table Model	Main Body (cc)	Gear Box (cc)
CNC(Z)105	110	Grease
CNC(Z)180, 202	500	Grease
CNC205	200	Grease
CNC(Z)260, 302	700	300
CNC(Z)260P, 302P	700	300
CNC(Z)321, 401	2,000	700
CNC(Z)400H	2,000	—
CNCB450	2,000	500
CNC(Z)501, 601, CNC801	7,000	1,500
CNC(Z)503	5,000	—
CNCB630	6,000	1,500
CNC802	14,500	2,500
CNC803	15,000	2,000
CNC1200		18,000
CNC1201		26,000
CNC1600		60,000
CNC180B, 202B	500	Grease
CNC260B, 302B	700	1,200
CNC321B, 401B	2,000	1,000
CNC180T, 202T		1,500
CNC260T, 302T		1,500
CNC321T, 401T		4,000
CNCB450T		5,500
CNC501T, 601T		8,000
CNC100-2W	540	Grease
CNC100-3W	720	Grease
CNC100-4W	900	Grease
NCT200	400	Grease
NSVZ180	500	Grease
NSVZ300	1,500	Grease
NSVX400		3,000
NSVX500		3,000
NSVX400T		5,000
NST250	1,300	Grease
NST300	1,800	Grease
NST500	10,000	Grease
TAT105		60
TAT200,250		Grease
TAT321,401		Grease

Required oil quantity for 5AX rotary table

Table Model	Axis	Main Body (cc)	Gear Box (cc)
5AX-100	Rotary	300	Grease
	Tilting	300	Grease
5AX-130	Rotary	350	Grease
	Tilting	400	Grease
5AX-150	Rotary	450	Grease
	Tilting	500	Grease
5AX-201	Rotary	400	Grease
	Tilting	300	Grease
5AX-250	Rotary		800
	Tilting	600	Grease
5AX-230	Rotary	700	Grease
	Tilting	800	400
5AX-350	Rotary		2,000
	Tilting	800	300
5AX-T(N)400	Rotary		14,000
	Tilting		4,000
5AX-B450(T)	Rotary		7,000(9,000)*1
	Tilting	3,000(5,500)*2	1,000(-)*2
5AX-550	Rotary	2,000	Grease
	Tilting	2,000	800
5AX-800	Rotary		8,000
	Tilting	4,000	2,000
5AX-2MT-105	Rotary	700	Grease
	Tilting	400	Grease
5AX-2MT-170	Rotary		2,000
	Tilting	700	300
5AX-2MT-200	Rotary		2,000
	Tilting	2,000	1,000
5AX-4MT-120	Rotary	2,000	Grease
	Tilting	700	300

*1 Rotary body working diameter: φ850mm *2 Tilting body: T-type

Assessment for Reliability & Quality.

Over Load Test

The wearing of the worm wheel is very small under very severe testing condition.

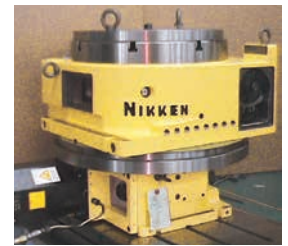

Brake Torque Test

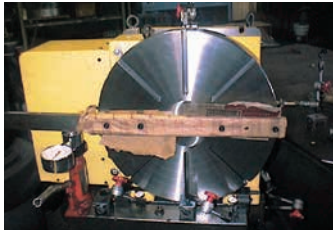

Rigidity Test

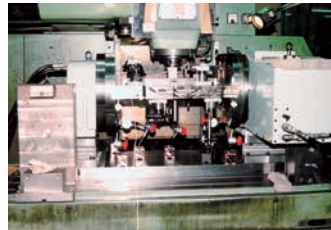

Cutting Stability Test

The micro vibration during machining or the surface finish are measured.



EMC Test

Electromagnetic Compatibility Test



Emission



Immunity

Water Proof Test



Declaration of Incorporation (EU)

Accuracy Measurement

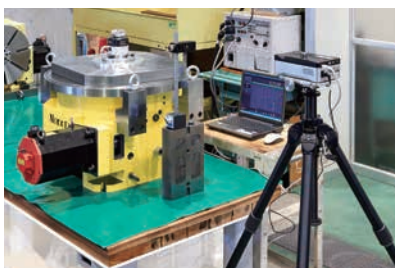

Indexing Accuracy Measurement by Laser



5AX-230 on 3 Dimensional Measuring Machine



Accuracy measurement with large 3 Dimensional Measuring Machine

Conditions of CNC Rotary Table when being used to CNC Special Purpose Machine

Not only indexing accuracy, the following conditions must be also filled for continuous operation of 24 hours. Namely, Load calculation, Indexing time, Durability etc. And the overseas service branches and after service ability are also important.

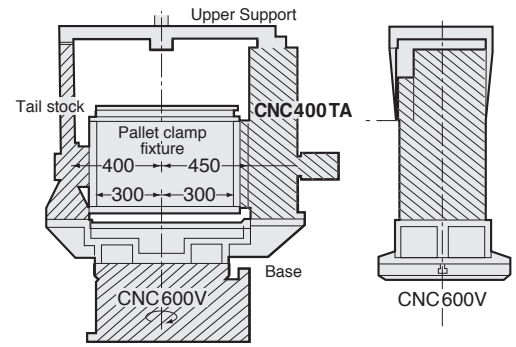

① Load Calculation

In case using conditions are beyond the specification of CNC rotary table, please inform us the work piece, jig fixtures, required indexing time etc. Then, we will calculate the load of your application, and select the suitable CNC rotary table. Please send us your 3D CAD data. (STEP or Parasolid)

No.	Shape	Quantity	Approx. Weight (Kg)	Approx. GD ² (GD ² /4)Kg ^{m²}
①	CNC400T Eccentricity: 450mm	1	260	59
②	Tailstock Eccentricity: 120mm	1	80	14
③	Base	1	11	10
④	Upper Support Parts	1	30	2
⑤	Pallet Clamp Fixture Eccentricity: 120mm	1	80	6
Total			560	91

② Indexing Time Comparison

Indexing Time = Acceleration Time + Rapid Positioning Time + Deceleration Time.

MAX. moving angle is 180°. Therefore, not only rapid positioning time, but also acceleration/deceleration characteristics is very important. The graph at right hand side shows that **CNCZ202** (high speed), with it's excellent acceleration/deceleration capability, gives a very substantial time saving of approximately 300 msec. on this 90° movement comparing with **CNC202** (standard).

CNCZ202: 500 msec.

CNC 202: 800 msec.

Item	Rapid Positioning Speed	Acceleration/Deceleration Time Constant
— (Red)	44.4min ⁻¹	150msec
— (Blue)	22.2min ⁻¹	100msec

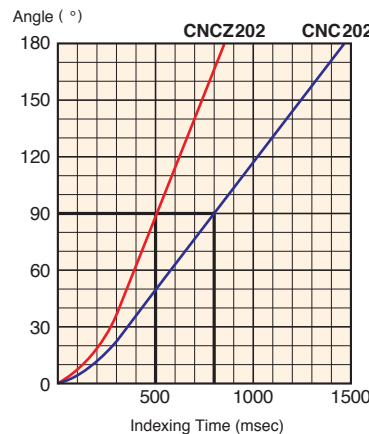

Item	Using Years	Indexing accuracy
— (Red)	At installation	Cumulated 10sec
— (Blue)	After 7 years	Cumulated 17sec

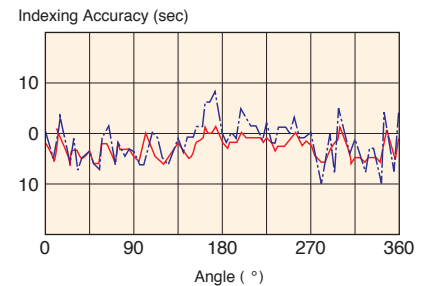

③ Durability

In 24 hours continuous operation, durability is one of the most important conditions.

Thanks to Carbide Worm System, NIKKEN CNC rotary table ensures highest anti wearing nature even at the severest load conditions with high speed indexing. The graph at right hand side shows the worm wheel & worm screw and accuracy inspection of the table having been used for 7 years on CNC special purpose machine in production line of automobile parts plant.



Worm System after 7 years used.

⚠ Caution

Regarding the rotation speed of the table

- For some models, the table rotation speed is based on 3000 r/min. of the servo motor. However, depending on the application such as huge unbalancing weight, motor manufacturer, or motor model, it may not be possible to rotate the servo motor at 3000 r/min.
- The continuous rotation of turning and grinding cannot be done except rotary tilting table with high speed DD motor. [☞ P.53](#)
- Always be careful not to inflict personal injury on any shop objects when unpacking this equipment.
- Caution should always be used when lifting this product. Especially when using lifting equipment. Manual lifting of this product may cause serious back injury. Always use safe lifting techniques.
- Install the rotary table on a well ventilated place hidden from direct sunlight, on a place not exposed to corrosive gas such as sulfuric acid and hydrochloric acid. Do not install the rotary table on a place with excessive high/low temperature. (Normal operating temperature: 5°C~40°C)
- Under the lower temperature condition, please warm the rotary table up just after power on. Or, please use lighter lubrication oil as another solution.
- Only the specified power voltage should be used. Incorrect power supply may result in fire.
- Always power off the machine before attempting any installation and wiring work. Failure to do this may result in serious personal injury or electric shock.
- The machine on which CNC rotary table is installed should have a complete cover or splash guard.
- When installing this product onto a machine tool, always pay special attention to the location of cables, hoses and hydraulic tanks (if used), to check for interference.
- Please make sure that all cables and hoses are sufficiently long to allow full axis travel.
- Always ensure that there is no interference with the CNC rotary table or tailstock unit of the ATC (Automatic Tool Change) position.
- Always ensure safe cable runs according to the instruction manual in order not to interfere with the machine operation. It is dangerous if the cables become entangled with the machine table or spindle unit.
- Always check the parallelism and squareness of the table to the machine axes and fix to the machine table using the fixings provided.
- Please follow the instruction manual for installation, wiring of cables and hoses. Failure to connect wiring correctly may cause fire or a serious accident.
- This table has been given a waterproof treatment, however if ingress of coolant should occur, stop using the table immediately. Failure to do so may result in the unit catching fire or causing serious electric malfunction.
- Always ensure that pneumatic or hydraulic hoses are connected correctly.
- Always keep the air filter clean to prevent water and dirt ingress from the air supply.
- Please ensure that the hydraulic pressure flows constantly on the pump line at brake clamp in the save energy type hydraulic circuit.
- Please use CNC rotary table within the specification. Exceeding the specification may cause defective components and irreparable damage. Please contact us in case of the beyond the specification before ordering. [☞ P.100](#)
- Never modify the table by yourself without previous agreement of NIKKEN
- Never to touch any moving parts. Failure to follow this instruction may result in serious personal injury.
- For the rotary table with the NIKKEN controller, firstly turn the power of NIKKEN controller off, then turn the power of main M/C off at the end of operation.
- Always remove swarf from the table after use. Long term operation without cleaning may cause damage to the internal mechanism.
- Always change the lubrication oil annually to prevent the gear wear.
- If a collision occurs with the table, power off the machine controller immediately and contact your distributor for repair.
- Always stop using the table if unusual noises are heard or the slackness or deflection of work piece and jig fixture are found. Irreparable damage may be happened. Please contact with your distributor for repair.

■ Specification of the rotary table to be used on the special purpose machines.

1. Custom made on the Table Face Plate
 - Drilled hole, tapped hole, or dwell pin hole etc.
 - Without T-slot or with T-slot
 - Additional process at center hole
2. The location of the Oil Sight Glass, Oil Supply Port and Drain Port can be changed.
3. How to be mounted on the Machine
 - U-groove
 - Additional tapped holes on the backside
 - Shift the guide key position
4. Modification of the Motor Cover
5. Rotary Joint [☞ P.81](#)
6. Built-In Pallet Clamping System [☞ P.92](#)
7. Special Color [☞ P.92](#)
 - Please order with the color sample or Munsell Color No.

When rotary table is used for horizontal use, there is no portion of the table body to be clamped for vertical use.

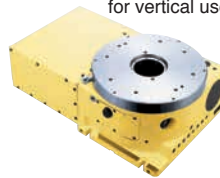

CNC401 without T slot for horizontal use



CNC302T without T slot



CNC202L without T slot

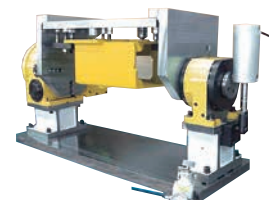

⚠ Selection of the CNC rotary table

- The support table is basically used in case of vertical application.
- The machining operation is generally light cut on aluminium materials, however, if the fixture or the component is large size, please make sure that the fixture inertia is within the MAX. work inertia.
- If the unbalance load is too big, it will affect on not only the indexing accuracy but also the durability. Please make sure the unbalance load will be within the following figures. [☞ P.57](#)
- In case of the unbalance load is large,
 - The high speed Z series rotary table is not suitable, please use standard rotary table.
 - Please installing the balance cylinder or counter balance.
 - Please advise us the details of the component, fig fixture, indexing time etc. prior to your order, and we will make a calculation of the load and select the best suitable rotary table for your application.
- If the huge amount of coolant has to be applied, we could prepare air purge (with pneumatic pressure of 0.03MPa) on the CNC rotary table body as an option. Please contact us the details.

⚠ Check point for trunnion fixture

- ① When installing the table onto the sub-base, measure and check as follows.

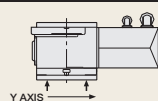

Parallelism between table & sub-base is recommended within 0.01mm

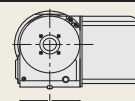

Difference between table center and sub-base center is recommended within 0.02mm

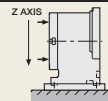

Squareness of table is recommended within 0.02mm

- ② Install the table & support table onto the M/C as follows.

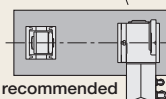

Center lines are recommended within 0.02mm

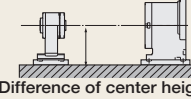

Difference of center height is recommended within 0.01mm

- ③ Trunnion fixture is recommended to be aligned as follows.

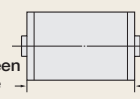

Squareness between center line & these faces is important

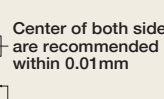

Center of both side are recommended within 0.01mm



Squareness is important

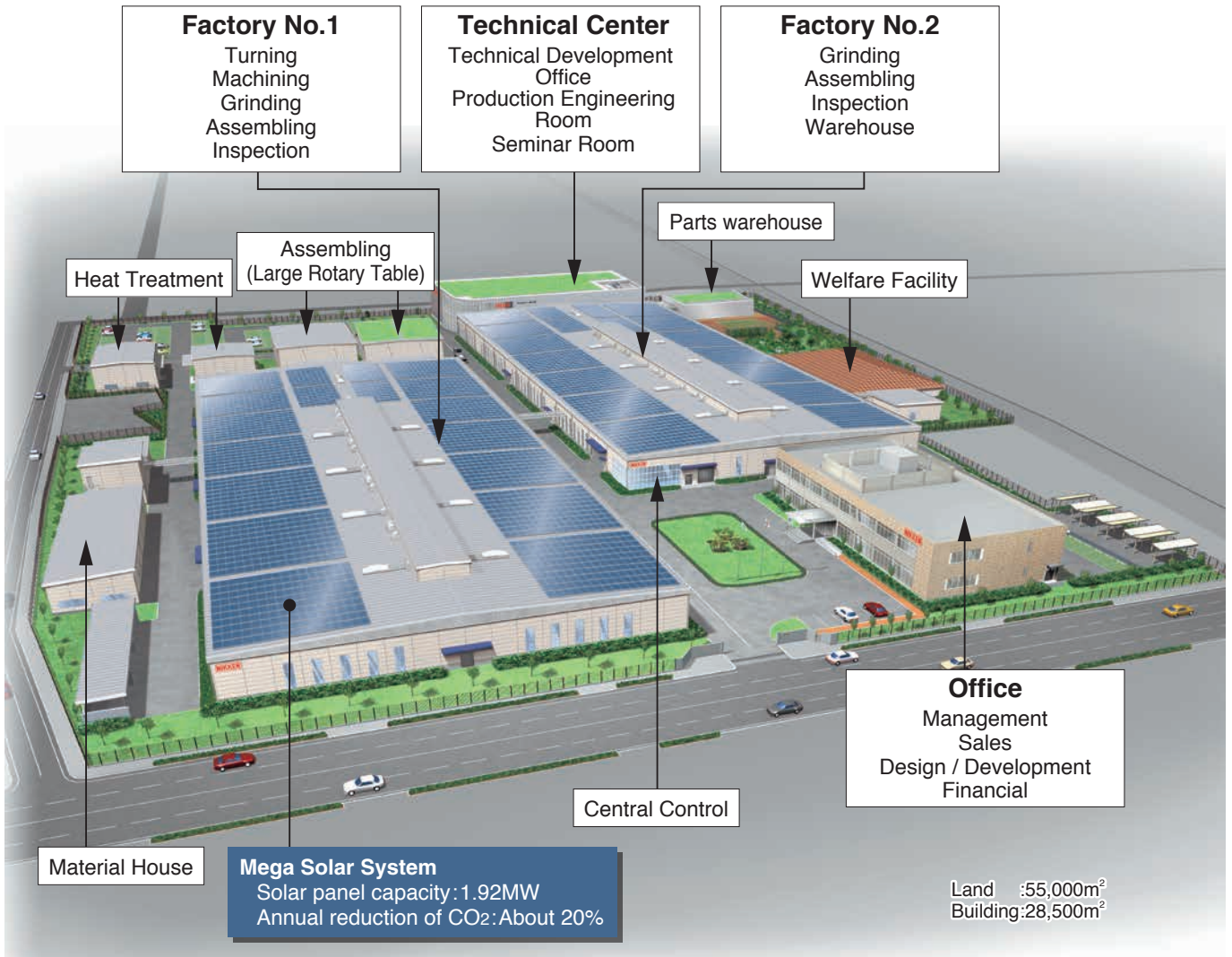

Carbonizing & Sub-Zero Treatment

NIKKEN is the only tooling product manufacturer which performs sub-zero treatment for tooling. This refers to a technique where -90 deg. ultra-low-temperature processing is performed after carbonizing and quenching in order to eliminate the residual austenite and to form 100% martensite compositions to prevent deterioration over time. This technique has been applied for block gauges and for bearings of the highest grade in the past. It is an example of how NIKKEN pays attention to those aspects which are often hidden from view and how we put our hearts and souls into each and every tooling product.



Ion Nitriding

Ion nitriding refers to a nitriding process where glow discharges are generated in a vacuum of a nitrogen-mixed gas atmosphere to heat the workpieces at a low temperature of 450 deg. while at the same time nitriding them by a sputtering action. This processing improves both the wear resistance and sliding performance. (It reduces the surface friction coefficient.) The experience and know-how of ion nitriding have been utilized in a large number of NIKKEN's products, including worm wheels for CNC Rotary Tables and Tough-Cut Skill Reamers.

NIKKEN SERVICE NET WORK



There are overseas Sales Branches in 14 countries. Each sales branch has stocks for toolings and CNC Rotary Tables, and service engineers look after the maintenance and service operation of our products. In the other region, e.g. East-South Asia, Ozaena, South America, Africa, etc., there are some distributors. At the production line in abroad, as there are many requirements for special tools and CNC Rotary Table to suit the special specifications, please ask us or distributors for spare tools and maintenance parts in advance.

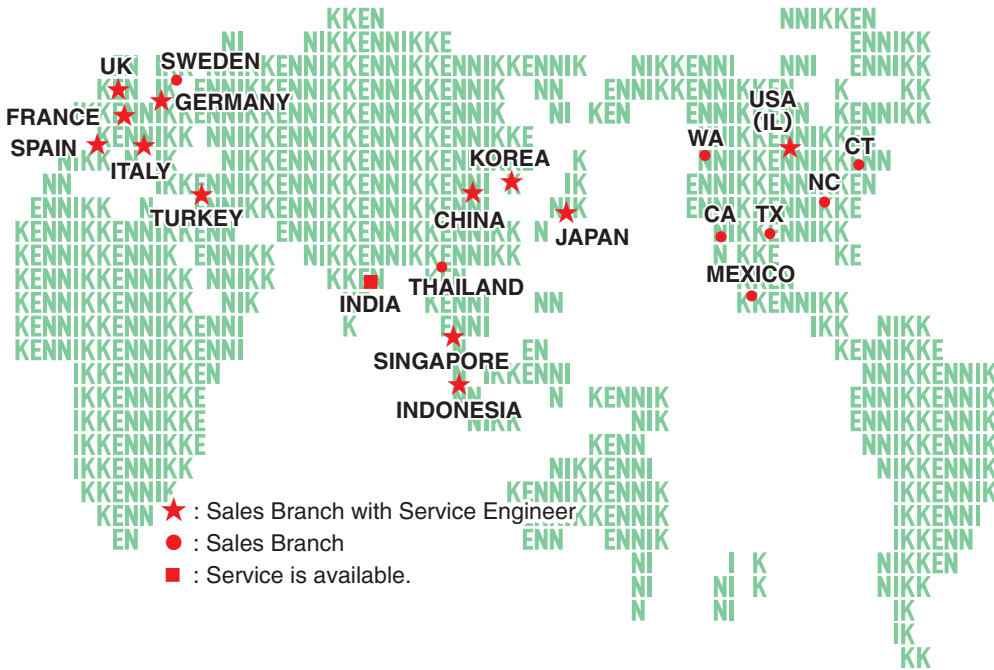

LYNDEX-NIKKEN (U.S.A.)



NIKKEN EUROPE & NIKKEN U.K (UK)



NIKKEN DEUTSCHLAND (GERMANY)



HERRAMIENTAS LYNDEX-NIKKEN (MEXICO)



PROCOMO-NIKKEN (FRANCE)



KOREA NIKKEN (KOREA)



NIKKEN SCANDINAVIA (SWEDEN)



VEGA INTERNATIONAL (ITALY)



OLASA (SPAIN)



CUTTING TOOLS (SPAIN)



NIKKEN CHINA (CHINA)



NIKKEN TURKEY (TURKEY)



SIAM NIKKEN (THAILAND)



NIKKEN ASIA (SINGAPORE)



NIKKEN INDONESIA (INDONESIA)

Discontinuation of CNC rotary table repair work

We have been repairing our CNC rotary tables that are no longer manufactured. However, more than 20 years have passed since the discontinuation of the following models, and it has become difficult to obtain maintenance parts. Therefore, we will basically discontinue repair work as of April 2024. These CNC rotary tables are also out of date in terms of rapid positioning speed and other mechanical specifications. As a replacement, please select a CNC rotary table with the latest functions from this catalogue.

Table model

●CNC100, 150, 170, 201, 230, 250, 320, 320V, 400V, 500V, 600V, 800V ●5AX-120, 170, 200, 300 ●NSV250

New Nikken China facility was moved to Qinzhou Road, Shanghai on 2014. JAN due to the business expansion in China. The standard items of NC tooling & CNC rotary table and each important spare parts are stocked for quick delivery.

You can access to Nikken China with Chinese, Japanese or English. Not only Chinese catalogue but also Chinese instruction manual are provided for Chinese domestic market. Our office has the show room to see and touch our products, and our presentation will be done more practically. Technical seminar of Nikken is also opened at user factory side.



Chinese engineer well trained in Japan is engaged in the service of our products. Different types of the NC controller for the CNC rotary table are provided for the trial running after repair. The most important spare parts are stocked. It is possible to stock the special spare parts of the custom-made tooling or CNC rotary table for further discussion. Please consider to make a contract of "Nikken Rotary Table Overseas Warantee Contract" for the CNC rotary table delivered to China.



The sales of nikken products through Internet is not started in China. For after service and the further maintenance, please purchase Nikken products through authorized distributors.



As North America's leading supplier of machine tool accessories, LYNDEX-NIKKEN is a wholly-owned subsidiary of NIKKEN Kosakusho Works., Ltd. - Japan. Backed by over a half century of experience, LYNDEX-NIKKEN sets the standard for high quality and high technology with a complete line of superior toolholders and machine tool accessories. From one source you can expect the best of both worlds: Extreme Quality and Advanced Technology.

LYNDEX-NIKKEN has a team of dedicated application and engineering staff available to advise you on your machining applications and to support our entire product line throughout the U.S., Canada, Mexico and South America. Our regional managers in Chicago, Los Angeles, Boston, Charlotte, Dallas and Seattle support our 1,000 plus distributors with machine tool accessories expertise. LYNDEX-NIKKEN provides expert process and product consultation for even the most demanding applications with full on-demand field support and ongoing training.

North American Facility

The LYNDEX-NIKKEN North America headquarters is centrally located near Chicago, Illinois. Our 50,000 sq ft. facility houses an inventory of over 12,000 machine tool accessories stocked for fast delivery. Over 95% of orders are shipped out same day. Our extensive inventory of products includes:

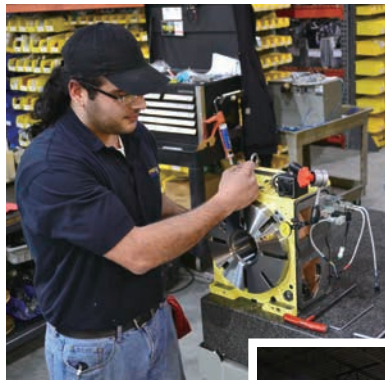
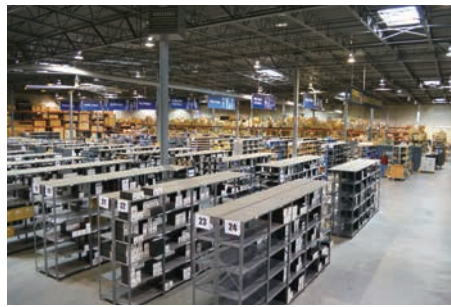

Products

- **Rotary Tables** - NIKKEN's complete line of CNC Rotary Tables are known worldwide for their wear-resistance, rigidity and high-speed rotation. NIKKEN rotary tables are built to provide high accuracy, increased production and a trouble-free long life.
- **Advanced Toolholders** - Maximize the potential of your machine tools with LYNDEX-NIKKEN's advanced toolholders.
- **Standard Toolholders** - LYNDEX-NIKKEN's complete range of quality-driven toolholding solutions are designed to meet your strictest requirements.

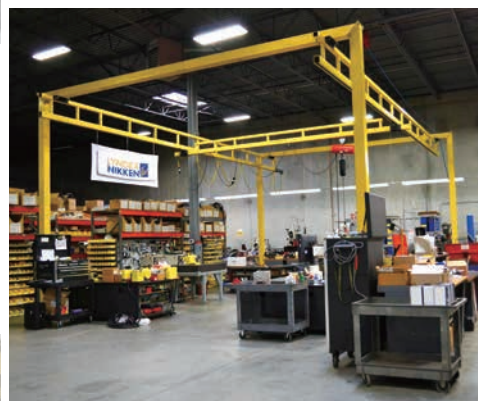

Service & Support

- Dedicated application and engineering support staff
- Support for entire product line covering the U.S., Canada, Mexico and South America
- On-demand field support and ongoing training
- Customer service and technical support staff
- Expert process and product consultation for even the most demanding applications
- Cutting trials and testing
- Service, repair and custom configuration completed on-site
- Attention to high-tech application demands, including high-speed and balanced toolholding solutions

The NIKKEN Euro Centre based in the UK was opened in 1999; from here we sell, distribute and support all products to our subsidiaries and dealers in over 20 countries around Europe.

In addition to carrying out the functions of NIKKEN UK in the United Kingdom (UK), we employ forty staff members and engineers. At the end of 2015, NICE (NIKKEN Innovation Centre Europe) opened in the AMRC manufacturing technology park, where it provides support to customers working with difficult-to-machine materials, particularly in the aviation and energy industries.



Product Inventory

NIKKEN Euro Centre facilities has a warehouse space of 13,000m². which holds over 50,000 individual items covering a range of some 4,000 product lines, including the latest generation of Single & Multi Axis CNC Rotary tables, thus making it the largest stock of NIKKEN products in Europe.

Our Technical Support and Training Section provides our existing customers and potential customers access to:

- A Multimedia based training facility that ensures our customers, through comprehensive training, will realize the full productivity potential of their application.
- A wealth of engineering expertise covering all aspects of application set-up, optimization and implementation that is available for the full life of the NIKKEN product.

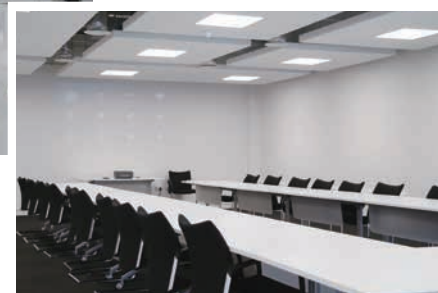

Our machining centre equipped with Testing Facilities enables us to:

- Research, develop and optimize all of our tooling systems.
- Demonstrate to our potential customers the advantages of using both NIKKEN Tooling and CNC Rotary Tables in their applications.

Our Service Department specializes in:

- Providing on-site inspections prior to rotary table repairs and refurbishment by our own NIKKEN trained service engineers.
- Providing tooling and rotary tables optimized to seamlessly integrate into any application.



Nikken Deutschland GmbH, a wholly owned subsidiary in Germany of NIKKEN Kosakusho Works, was established in 2003 to take over the sales activities of the previous distributor. In the beginning based in Russelsheim, which is a town made famous by the manufacturing complex of Opel, the company was located about 15 minutes away by car from Frankfurt airport. Germany has ranked at the top of the machine tool industry for many years, and is also the supply source of machine tools that are fuelling the significant expansion now taking place in Eastern Europe. Nikken Deutschland GmbH had its base at the centre of the huge market of Germany and Eastern Europe, and continues to broaden the range of the company's sales operations from ULM office now.

NIKKEN has achieved some impressive successes in Germany with its CNC rotary tables and tool holders thanks to a long sales history of the company's sales activities. A sales force consisting mainly of German personnel stands on the front line of this activity to address the sales and servicing needs of the entire country. More specifically, the company provides technical advice, repairs, aftersales support and other services to end users, distributors and machine dealers.



To enable speedy delivery of standard items in the German market and of popular products compliant with European standards, Nikken Deutschland GmbH works closely with Nikken Euro Centre to keep a full stock at its disposal. The company uses the most appropriate type of delivery in each case, including parcel post, DHL, door-to-door service and flash shipment, to meet the demands of customers.

The sales territory of Nikken Deutschland GmbH spans the vast area of eastern Europe and covers such countries as the Czech Republic, Slovakia, Austria, Poland, Hungary, Romania and Bulgaria, all countries in which Japanese companies are rapidly expanding their business. The service is not limited to sales, but engineers make on-site adjustments, repairs and service calls as well.

Nikken Deutschland GmbH has participated in and contributed to many trade shows and exhibitions held in Germany, including the EMO show, METAF, AMB and EURO MOULD. The company's fully furnished showroom is a Mecca of information to the constant stream of visitors who can inspect products and examples of machining, as well as receive application advice and technical training. They can handle NIKKEN's products for themselves, learn about the construction and capability of the CNC rotary tables, and learn about the accuracy and other features of NIKKEN's products.

A complete support organisation is in place to ensure that advice is relayed promptly by telephone and other rapid communication media, that repairs or delivery of tool holders and CNC rotary tables are carried out promptly with all due diligence, and that emergency service calls are responded to rapidly.

To make it possible to support all types of motors and controllers for NIKKEN's CNC rotary tables, the company has set up trial run equipment that accommodates many different motors, and offers a full range of accessories including tailstocks, support tables, scroll chucks and collet chucks adapted to the CNC rotary tables. The fact that NIKKEN's CNC rotary tables are endowed with outstanding durability and that a complete support service is provided instils confidence in users that the equipment will give outstanding service in the years ahead.

Procomo France S.A.S was established 30 years ago with the avowed intent to deliver the high-accuracy and high-quality tool holders and CNC rotary tables as well as related services, applications and after-sales servicing, into the hands of engineers in France. A major milestone in the company's history was marked in 2006 with the change of the company name to PROCOMO-NIKKEN, and the company took on a new lease of life as NIKKEN's wholly owned subsidiary in France.



In 2005, PROCOMO-NIKKEN embarked on a complete renovation of its buildings and facilities in order to make it possible for users to gain hands-on experience of NIKKEN's products in a bright and comfortable environment.



In the meeting room, which is fitted out with all the latest multimedia technology, technical seminars are regularly held so that attendees will come away with a clear understanding of NIKKEN's products and technology. The showroom is where videos of cutting operations are screened, and visitors can actually handle some of NIKKEN's products in this room as well. The machining center, which is used for cutting trials, enables visitors to identify what makes NIKKEN's products different from those of other companies and to judge how impressive are the machining accuracy and advanced cutting capabilities of NIKKEN's products. As the top tool holder manufacturer, NIKKEN believes is that once customers have their own personal experience of the low machining noise, attractive-looking cut surfaces and uniform discharge of chips, they will be convinced that they can completely trust in and depend on the expertise and capabilities of the company.



The stocks of a large number of standard products are always on hand, enabling the products that customers need to be delivered in the shortest possible time. The NIKKEN Euro Centre and PROCOMO-NIKKEN retain constant and close contact; together they take on the challenge of how to machine products in a more rationalized manner, in a shorter time and to a higher accuracy so that France's engineers can meet every need of the French marketplace.

NIKKEN has already earned an enviable reputation in the global marketplace for the high accuracy and outstanding wear resistance of the company's CNC rotary tables. PROCOMO-NIKKEN has a team of five engineers dedicated full-time to providing users with application support prior to placing orders for tool holders and CNC rotary tables and to carrying out the preparation for shipment, education and training programs, maintenance and repairs, and servicing. This support network delivers a wide range of services, while willingly taking up the challenge of coming to grips with new applications.

WormgearStatus / BacklashStatus

From March 2020, the **WormgearStatus** data are collected at shipment for all CNC rotary tables with FANUC motor. As a result, the **WormgearStatus** service and **BacklashStatus** service are available as optional paid services. Please refer the contents of these services below.

If you would like these service, please contact us. The actual expenses for transportation and accommodation are required separately.

The key items are the CNC rotary table type and serial number. It is necessary to write the control program for **WormgearStatus / BacklashStatus** to the user's FANUC NC controllers.

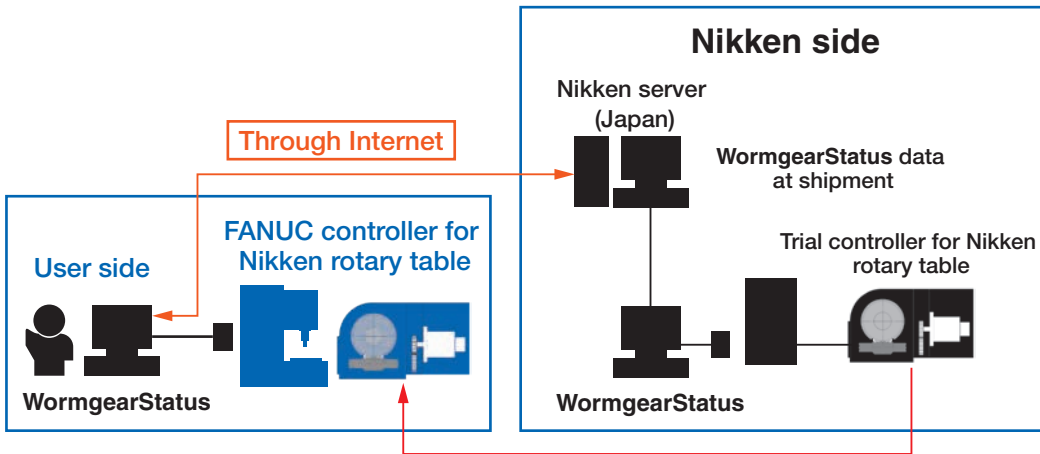

Data after usage

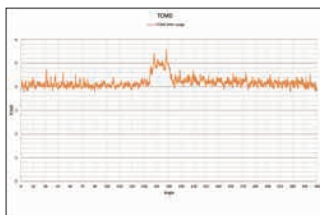

Comparison

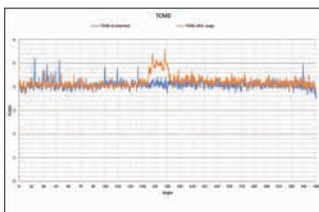

Estimation of the gear wear

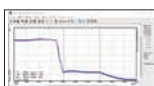
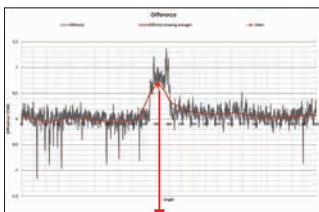
CNC rotary table at shipment
Table type and serial number

Data at shipment

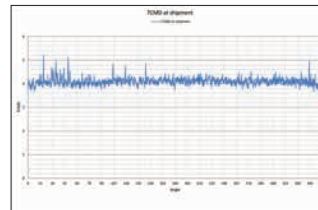

WormgearStatus service JAPAN, USA, EU, China: PAT.P

WormgearStatus data is the torque data, when the full stroke of a CNC rotary table (example: rotary axis: 0° to 360°, tilting axis: 0° to 105°) is rotated at 360 deg/min. **WormgearStatus** data at shipment is collected and stored according to the CNC rotary table type and serial number in the Nikken server in Japan. **WormgearStatus** data after usage will be collected locally and compared with the data at shipment, then estimate the gear wear position.

BacklashStatus service JAPAN: PAT, USA, EU, China: PAT.P

BacklashStatus will be checked the backlash amount without manual intervention to the position, where gear wear is estimated ;

- 1) The angles, that is estimated as the gear wear position by **WormgearStatus**, will be checked.
- 2) For the CNC rotary tables on NC single purpose machine, the angles to be positioned are fixed and always same positions. In this case, enter these angles to be checked, and activate **BacklashStatus**.
- 3) If required, backlash compensation function and pitch error compensation function can be utilized without manual intervention for better positioning accuracy.

WormgearStatus / BacklashStatus uses FANUC Servo Guide.
WormgearStatus / BacklashStatus is a registered trademark in Japan.

